



2GIG® GC3/GC3e Security & Automation System

Installation and Programming Guide

10023748A X3



WARNING: OWNER'S INSTRUCTION NOTICE
Not to be removed by anyone except occupant

The 2GIG, GC3, GC3e, GoControl, and Linear logos are registered trademarks of Nortek Security & Control LLC in the United States and/or other countries. Other Nortek Security & Control trademarks may also appear in these materials. Other names or brands may be claimed as the property of others. For more information, contact your 2GIG alarm dealer for pricing or visit www.nortek.com, www.nortekcontrol.com, or www.2gig.com.

This document utilizes the Cue gestural icon system by P.J. Onori, which is available under a Creative Commons Attribution-ShareAlike 3.0 United States (CC-BY-SA-3.0) license.

Information in this document is subject to change without notice. The availability of particular products, services, and features may vary by region. Please check with your local dealer for further details and availability of language options.

No part of this publication may be reproduced, stored in a retrieval system, or transmitted in any form or any means electronic or mechanical, including photocopying and recording for any purpose other than the purchaser's personal use without the written permission of Nortek Security & Control.

Nortek Security & Control
5919 Sea Otter Place, Suite 100
Carlsbad, CA 92010
USA
800-421-1587

Contents

Introduction	5
About this Guide	5
Introduction to Smart Areas™	5
Document Conventions	6
Technical Support	6
Planning the Installation	7
System Features and Capabilities	7
Internal Components	9
Additional Accessories	10
Important Information	11
Create the Installation Plan	11
Installation Steps	15
Installing the System	16
Install the GC3 Cellular Radio Module	16
Install/Replace the Cellular Radio Module	16
Mount the GC3 Panel's Backplate	21
Connect an External Alarm Sounder	23
Connect the Hardwire Loops	24
Connect the Power Wires	25
Control Panel Wiring Diagram	27
Terminal Blocks Wiring Diagram	28
Connect the Backup Battery	29
Hang the GC3 Panel	29
Ethernet Module Installation (Optional)	29
Install the Retaining Wall Bracket and Connect the AC Power Supply	30
Update the GC3 Panel Firmware	31
Navigate to the Installer Toolbox	32
Broadband	32
Attaching to a Wireless Network	33
Selection Buttons	33
Wired (Ethernet)	34
Programming Sensors and Peripherals	37
Navigate to the System Configuration Menu	37
Program a Wireless Zone	37
Next Steps	41
Program a Wired Zone	42
Program a Keyfob	45

Program a Keypad	49
Next Steps	53
Reset a Zone, Keyfob, or Keypad to the Factory Default Settings	53
Panel Programming	54
Q1: Enter installer code (4 digits)	54
Q2: Lock installer programming	54
Q3: Lock default programming	54
Q4: Exit delay, in seconds (45-120)	54
Q5: Entry delay 1, in seconds (30-240).	54
Q6: Entry delay 2, in seconds (30-240).	55
Q7: Remote services provider.	55
Q8: 2-way voice	55
Q9: Disable siren after two-way audio	55
Q10: Police emergency key	56
Q11: Fire emergency key	56
Q12: Emergency key.	56
Q13: Quick arming	56
Q14: Auto stay.	56
Q15: Exit delay restart.	56
Q16: Allow quick exit.	57
Q17: Quick bypass	57
Q18: Alert on disarm with keyfob after alarm	57
Q19: Keyfob arm/disarm confirmation.	57
Q20: Keyfob/remote arming mode on system not ready.	57
Q21: Z-Wave feature.	57
Q22: Smart Home Controls require master code	57
Q24: Temperature display units.	58
Q25: Swinger shutdown count (1-6)	58
Q26: Cross sensor zones 99-100	58
Q27: Cross sensor timeout, in seconds (10- 120).	58
Q28: Siren supervision time	58
Q29: CS lack of usage notification time, in days (0-255)	59
Q30: Radio modem network failure time, in minutes (0-255)	59
Q31: Radio network failure causes trouble	59
Q32: Radio network failure reports	59
Q33: Broadband network failure time in minutes	59
Q34: Broadband network failure causes trouble	59
Q35: Broadband network failure reports	60
Q36: Periodic test, in days (0-255)	60
Q37: Alarm cancel time, in minutes (5-255)	60
Q38: Alarm cancel display.	60
Q39: Alarm abort window transmission delay	60
Q40: Burglary bell cutoff time	60
Q41: Fire bell cutoff time	60
Q42: Trouble doesn't sound at night	61
Q43: Z-Wave siren mode	61
Q44: Open collector #1 output	61
Q45: Open collector #2 output	61
Q46: Time to detect AC loss, in minutes	62
Q47: Random AC loss report time	62
Q48: Programming mode entry reports to CS.	62

Q49: Trouble reports to CS	62
Q50: Trouble restore reports to CS	62
Q51: Manual bypass reports to CS	62
Q52: Bypass restore reports to CS	62
Q53: AC loss reports to CS	62
Q54: AC restore reports to CS	63
Q55: System low battery reports to CS	63
Q56: System low battery restore reports to CS	63
Q57: RF low battery reports to CS	63
Q58: Sensor low battery restore reports to CS	63
Q59: System disarmed reports to CS	63
Q60: System armed reports to CS	63
Q61: Alarm restore reports to CS	63
Q62: Smart test reports	64
Q63: RF jam causes trouble	64
Q64: System tamper causes trouble	64
Q65: Auto unbypass for manual bypass	64
Q66: Force bypass reports	64
Q67: Event log	64
Q68: Allow backlight always on (demo mode)	64
Q69: Smart Areas	64
Q70: Main Panel Sounder Follows	65
Q71: Security pin code length	65
Restore the Factory Default Settings	65
System Configuration Reference	66
Sensor Programming Reference	66
Panel Programming Reference	71
Features to Limit False Alarms	75
Image Sensor	76
Smart Home Settings Menu	76
Smart Home Settings Menu	76
Navigate to the Smart Home Settings Menu	76
Add a New Device	77
Remove a Device	78
Check the Network	79
Rediscover the Network	79
View All Devices	80
Associating Z-Wave Devices	84
Reset the Controller	85
Learn Controller	86
Testing the Installation	87
Disable the Piezo Sounder	87
Perform a Walk Test	87
Verify the Radio Status	88
Adding a Demo Video	88
Demo Mode	88
Limited Warranty	91
Waste Electrical and Electronic Equipment (WEEE) Statement	91
WARNINGS	91
Limitations of Alarm Products	91
Risk of Noise Induced Hearing Loss	91

Introduction

Before you get started, review this information.

About this Guide

This guide applies to the GC3 and GC3e security panels. All references to the GC3 panel, unless otherwise noted, apply to both the GC3 and GC3e.

This guide is designed for distributors, alarm dealers, and professional installers of the GC3 Security & Automation System. It provides general system information, safety precautions, and step-by-step instructions for installing and setting up the system. It is intended for use only by professional installers who are employed by or under contract with an authorized 2GIG alarm dealer.

For a list of 2GIG alarm dealers and distributors in your area, visit: <http://www.nortekcontrol.com> or <http://www.2gig.com>.

Introduction to Smart Areas™

Smart Areas is 2GIG's new partitioning solution. Partitioning is the process of dividing security sections of a home or building into smaller areas so that users can arm some sections of the house while leaving other areas disarmed. This provides home and building owners both security and convenience, as it allows them to walk through their structure without concern of tripping alarms for areas they'd like to keep secure and armed. Some examples of partitioning use cases include:

- » Arming a section of a room that contains a safe that contains gun collections or valuables. These areas may not be accessed as frequently as the other areas in the room.
- » Having a portion of the home designated for use by others, such as guests or property rentals. Partitioning enables the homeowner to arm some sections of the house they'd like to be 'off limits' to other people.
- » Disarming the garage while the homeowner is at work to allow a package to be delivered and stored safely on the premises.
- » Secure swimming pool or spa area to help reduce the risk of drowning accidents. In California, it is now required that newly-built pools and spas include at least one safety measure, including an alarm.

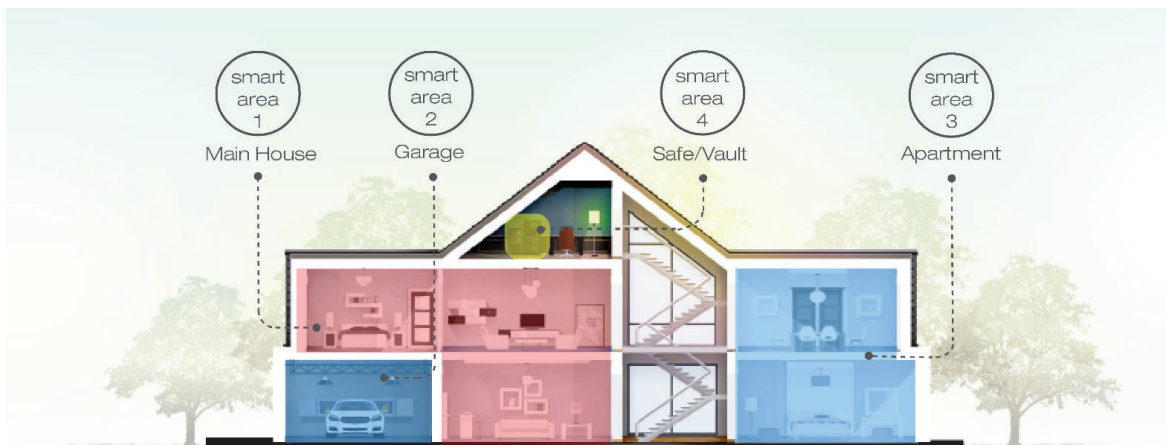

Smart Areas was designed for ease of setup and everyday use. For installation, the process for adding device enrollments has been simplified. All smart area parameters are displayed on the screen for quick scanning. This reduces time for the installer, who with legacy partitioning systems would have to memorize the codes and work flow, in addition to working through each parameter in a list to verify them. With the addition of Smart Areas, the GC3 becomes a self-contained partitioning panel, complete with user interface, controller, wireless transceiver, and communicator (cell radio and/or Wi-Fi) all-in-one package. This reduces complexity for the installer. All of the equipment is self-contained; there are no modules that require additional set up procedures.

For the end user, Smart Areas is a one-touch solution that provides Global System Access. They can now access any partition/Smart Area with appropriate authorization. 'Arm/Disarm' and 'Emergency/Panic' functions can be accessed quickly. No matter where in the menu a user finds themselves, all they need to do is press the 'Home' button and they immediately return to the 'Arm/Disarm' screen. Past partitioning examples required users to swipe from screen to screen. This added time, complexity and confusion for the user. The simplified user interface will reduce confusion and frustration for those who may not interact with their security system every day. With the common tasks up front, it's easy to select without having to memorize.

Document Conventions

This section describes the document conventions used in this guide.





Safety Precautions and Notations

It is imperative that you observe all of the safety precautions documented in this guide. For your safety and the safety of others, the following table details how this guide calls special attention to information intended to safeguard life, health, and property.

DANGER!!! This notation is used to indicate hazardous situations which, if not avoided, will result in serious injury or death.	WARNING!! This notation is used to indicate potentially hazardous situations which, if not avoided, could result in serious injury or death.
CAUTION! This notation is used to indicate a potentially hazardous situation which, if not avoided, could result in minor or moderate injury.	IMPORTANT: This notation is used to indicate a situation which, if not avoided, could result in property damage, equipment damage, or data loss.
NOTE: This notation is used to call attention to notable information that should be followed when installing, servicing, or using this product.	TIP: This notation is used to call attention to helpful hints related to using the product.

Touchscreen Navigation

This table describes the action words used to inform users of methods for touchscreen navigation.

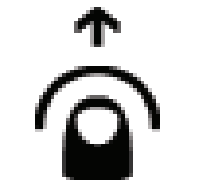
Glyph	Action Word	Glyph	Action Word
	Tap (or single tap)		Swipe left
	Touch and hold		Swipe right
	Swipe down		Swipe up

Technical Support

Should you require support services for this system, contact 2GIG Technical Support at Nortek Security & Control.

For support in the USA and Canada, contact 2GIG Technical Support at Nortek Security & Control:

- » Telephone: 855-2GIG-TECH
- » Email: 2gigtechsupport@nortek.com Dealer Site: dealer.2gig.com
- » Websites: www.nortekcontrol.com and www.2gig.com

For support outside of the USA or Canada, contact your regional 2GIG distributor. For a list of distributors in your region, visit the websites above.

Planning the Installation

System Features and Capabilities

If you're familiar with other 2GIG Control Panels, you'll notice the new GC3 Panel from Nortek Security & Control offers the very best components of the GC2 Panel and has been transformed by a major visual upgrade— offering a larger touchscreen and an intuitive user interface featuring convenient, gesture-based navigation.

GC3 Control Panel - Front View



Features

The system includes:

- » **Touchscreen Display:** A large, full-color, 7-in (17.8 cm) diagonal touchscreen with an intuitive, gesture-based user interface.
- » **Piezo Sounder and Internal Speaker:** An 85 dB Piezo Sounder sounds external alarms. An internal speaker to delivers voice annunciations, chimes, other system notifications.

CAUTION! Long or repeated exposure to sounds at or above 85 dB can lead to Noise-Induced Hearing Loss (NIHL).

- » **Alarm Button/LED Indicator:** Tap this button to show Panic, Fire, and Emergency buttons. For more information, see the GC3 Security & Automation System Fingertip Guide.
- » **Home Button/LED Indicator:** A button to wake the touchscreen and give users the ability to return to the touchscreen's Home screen. For more information, see the GC3 Security & Automation System Fingertip Guide.
- » **Removable Faceplate:** A removable faceplate concealing a door lock for the Cellular Radio Module bay.
- » **Microphone and Speaker:** A built-in microphone and speaker provide clear 2-Way Voice communication during alarm events between users at the GC3 Panel and operators at the Central Station.
- » **Cellular Radio Module with Internal Antenna:** A snap-in Cellular Radio Module with an internal antenna that fits neatly in the side panel.
- » **24-Hour Backup Battery:** A 24-hour backup battery to support the GC3 Panel during temporary AC power failures and outages.
- » **USB Port:** A convenient USB port at the top of the GC3 Panel that can be used with a USB thumb drive (not supplied) to update the system's firmware. See "Update the GC3 Panel Firmware."
- » **WiFi:** The built-in WiFi module allows the system to be connected to a WiFi network for dual path communication, OTA updates, and connection with secondary keypads.
- » **Ethernet:** (optional) An Ethernet module can be added to the system to allow for a hardwired connection to a local network for dual path communication, OTA updates, and connection with secondary keypads.
- » **Access Point:** The built-in Access Point allows for a direct connection with secondary keypads via WiFi without the need to connect to a local network.

Capabilities

The system includes these capabilities:

- » **Smart Areas:** Smart Areas allows for partitioning the system. Partitioning is the process of dividing security sections of a home or building into smaller areas so that users can arm some sections of the house while leaving other areas disarmed. This provides home and building owners both security and convenience, as it allows them to walk through their structure without concern of tripping alarms for areas they'd like to keep secure and armed.
- » **Security Codes:** The system supports a maximum of 100 unique, programmable, security codes for accessing system functions. You are provided with one (1) Master User Code, one (1) Duress Code, and one (1) Installer Code (reserved for use by 2GIG alarm dealers and installers), and the ability to create 98 additional user codes for accessing the system.
- » **Z-Wave® and Z-Wave Plus™ Compatibility:** Installers (and end users, if configured on the system) can add up to 232 smart home devices to communicate with the GC3 Panel using the Z-Wave and Z-Wave Plus wireless communication protocol. The GC3 Panel can be included and operated in any Z-Wave network with other Z-Wave certified devices from other manufacturers and/or other applications. All non-battery operated nodes within the network will act as repeaters regardless of vendor to increase reliability of the network. This device is a security enabled Z-Wave Plus product that is able to use encrypted Z-Wave Plus messages to communicate to other security enabled Z-Wave Plus products.
- » **2-Way Voice:** (Optional) Operators at the Central Station can communicate directly with end users through the GC3 Panel . Operators can also silently listen-in after receiving a user duress report.
- » **Date, Time, and Weather Forecasts¹:** Users can view the current date, time, and weather forecast in an easy-to-read format.
- » **System Vocabulary/Voice Descriptors:** A list of vocabulary words integrates with the on-screen user interface and audio announcements. This lets installers customize the sensor names that display on the GC3 Panel , as well as for the audible system announcements. For example, when someone opens the front door, the system can be set up to announce "front door."

¹ Date, Time and Weather Forecasts are supported by most Remote Service Providers in most regions. Consult your provider to determine if this feature is enabled.

Internal Components

This illustration details the GC3 Panel's internal components.

GC3 Panel - Internal Components

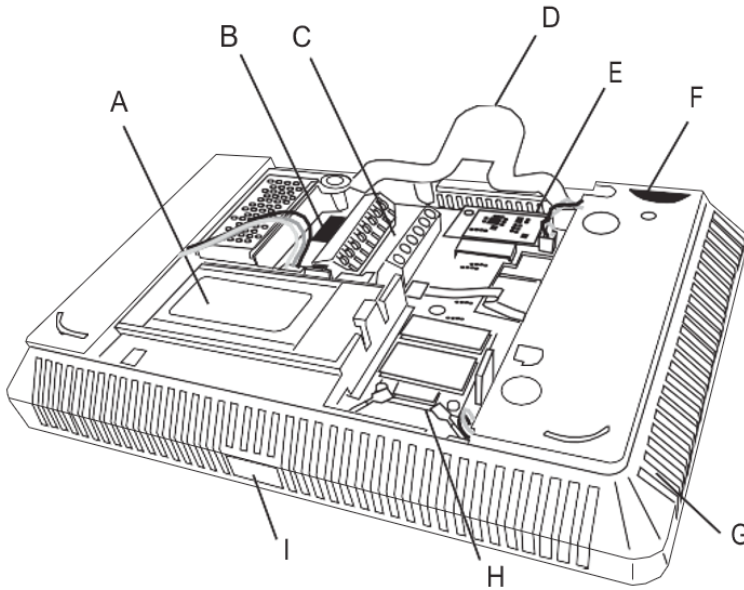

Callout	Component	Description
A	Backup Battery	A backup battery used with the GC3 Panel to extend service during a power outage.
B	Cellular Radio Module	An on-board digital communicator transmits alarms and trouble alerts to the Central Station, and also supports 2-Way Voice communication.
C	Terminal Block	Two terminal blocks with screw-terminal positions for connecting the GC3 Panel to electrical power (PWR+/PWR1), hardwire loops/wired zones (ZONE1/ZONE2), solid state output (BELL+/BELL-), and an open collector output (OCL1/OCL2). NOTE: Terminals are still marked as 2 Wire Smoke but 2 Wire smoke is not supported
D	Third Hand Hanging Strap	A durable hanging strap provides installers with an extra hand when installing and servicing the GC3 Panel.
E	Receiver Board	The main receiver board.
F	Piezo Sounder	An internal 85-dB Piezo Sounder.
G	GC3 Panel Siren/ Speaker	An internal speaker that sounds loud, clear alarms, navigation tones, alert tones, and supports 2-Way Voice communication.
H	WLAN Card	A Wireless LAN card to support the GC3 system's self-contained Wi-Fi network.
I	USB Port	A built-in USB port for updating the panel's firmware.

Additional Accessories

The installer typically sets up the system to communicate with a variety of wired and/or wireless sensors. Some sensors are visible on the wall or ceiling. For example, Wireless Smoke/Heat/Freeze Alarms and Wireless Carbon Monoxide Detectors. Others may be hidden in door jambs. For example, Recessed Door/Window Contacts. Sensors might also be installed in additional locations. For example, a Glass Break Detector and a Passive Infrared Motion Detector.

NOTE: A variety of 2GIG and GoControl branded devices are compatible with the GC3 Security & Automation System. Sensors manufactured by other companies may also be compatible with the system. For information, visit dealer.2gig.com

IMPORTANT: This notation is used to indicate a situation which, if not avoided, could result in property damage, equipment damage, or data loss.

IMPORTANT: To ensure that the system's sensors are operating properly, it is important for 2GIG alarm dealers and system owners to ensure sensor batteries and wireless signals are tested at least once a year.

Depending on the specific installation, systems may also be installed with one or more of the following 2GIG accessories:

Kits & Keypads

- » 2GIG Control Panel Desktop Kit
- » 2GIG SP1 Keypad
- » 2GIG SP2 Keypad
- » 2GIG PAD1

Radios & Antennas

- » 2GIG Cellular Radio Module
- » 2GIG External Attic Mount Antenna

Sensors & Peripherals (eSeries sensors are only compatible with the GC3e panel)

- » 2GIG Thin Door/Window Surface Contact
- » 2GIG Recessed Door/Window Contact
- » 2GIG Passive Infrared (PIR) Motion Detector
- » 2GIG Glass Break Detector
- » 2GIG Smoke/Heat/Freeze Alarm
- » 2GIG Smoke/Heat Detector
- » 2GIG Panic Button Remote
- » 2GIG Carbon Monoxide Sensor
- » 2GIG Takeover Module
- » 2GIG Doorbell
- » Universal Garage Door Receiver
- » 2GIG Tilt Sensor
- » 2GIG Bypass Sensor
- » 2GIG Flood Sensor
- » 2GIG Repeater

Z-Wave Smart Home Controls

Consult your 2GIG alarm dealer for information about installing a wide variety of compatible Z-Wave smart home controls including:

- » Lights
- » Locks
- » Thermostats
- » Garage Door Controllers

Important Information

The GC3 Security & Automation System conforms to the Security Industry Alarm Coalition's *ANSI/SIA CP-01-2010: Control Panel Standard - Features for False Alarm Reduction*. The system also meets the residential security system certification criteria for the ETL Listed Mark.

For Residential Settings

When installing the system in a residential setting, be aware of the following:

- » **Fire warning systems must be installed in accordance with national codes:** In the United States, fire warning systems must be installed in accordance with *ANSI/NFPA 72: National Fire Alarm and Signaling Code* and *ANSI/NFPA 70: National Electric Code*. Before installing this system, always ensure that you are in compliance with any national, regional, and local laws, rules, and/or guidelines.
- » **A permit may be required for this alarm system:** Some cities and municipalities may require an alarm system permit. Before installing this system, always ensure that you are in compliance with any national, regional, and local laws, rules, and/or guidelines.
- » **This system is intended for use with approved-model smoke alarms only:** For use as a smoke alarm system, there must be at least one (1) approved 2GIG-branded smoke alarm programmed into the GC3 Panel. See dealer.2gig.com.
- » **Failure to follow ETL requirements voids this system's ETL Listed Mark:** Failure to install the GC3 Panel and accessories in accordance with the ETL requirements documented in this manual voids its ETL Listed Mark.

Operating Temperature

The recommended storage temperature for the GC3 Panel is -10°C to 60°C (14°F to 140°F). For optimal use, operation temperature is 0°C to 49°C (32°F to 120°F). No altitude range limitations have been reported while transporting the GC3 Panel.

Create the Installation Plan

Before installing the system, the first step is to create an installation plan for the premises. Next, determine the mounting location for all system components, including the GC3 Panel and all sensors. If the system includes wired sensors, you will need to connect the wiring to the GC3 Panel's terminal block.

Recommended Tools and Equipment

To install the system, these tools and equipment are recommended:

- » 2-Conductor Power Wire (if connecting the GC3 Panel's power supply to the system's terminal block)
- » Drywall Saw (or Equivalent)
- » Ladder
- » Magnetic Phillips Head Screwdriver
- » Screwdrivers
- » Staple Gun
- » Wire Stripper

Where to Mount the GC3 Panel

When choosing a location for mounting the GC3 Panel, work with the end user to determine the best location. See also "Create the Installation Plan" above. For best results, keep the following items in mind:

- » Always choose an indoor location that is protected from temperature extremes.
- » Always choose a location that is above ground and centrally located.
- » Always choose a location where you can connect the GC3 Panel to an unswitched outlet. Do NOT connect the GC3 Panel to a switch-controlled outlet.
- » Always choose a location above ground level. Do NOT install the GC3 Panel below ground level, as this can impair wireless range.
- » Avoid choosing a location that can be easily viewed from doors or windows.
- » Avoid choosing a location that is within reach of small children.
- » Avoid choosing a location in direct sunlight.

NOTE: If mounting the GC3 Panel on a wall is not an option, the 2GIG Desktop Kit can be purchased for use with the GC3 Security & Automation System. This is an accessory that lets one mount the GC3 Panel on a stand that can be placed on a flat surface, such as desk or counter. Use of this option may affect compliance with state or regional codes.

Where to Place Wireless Sensors

When placing the system's wireless sensors, it is important to remember that they communicate with the GC3 Panel over radio frequency (RF). This subjects the system to radio interference, which can be caused by a variety of sources, such as other RF devices, construction materials, or even when placing sensors in close proximity to other appliances, electronic devices, or electrical wiring.

CAUTION! While the GC3 Panel includes a sensitive receiver that typically allows for placement of wireless sensors in nearly all locations, it is important to always install sensors in areas that provide the best possible signal strength.

To ensure the system and sensors are placed appropriately, review the following illustration.

Control Panel Location Relative to Sensors

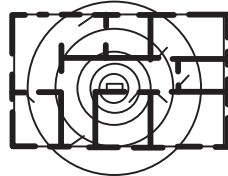

CORRECT
Centrally Locate
Control Panel



INCORRECT
Sensors at the other end of the
house might be too far away

Control Panel Location Height

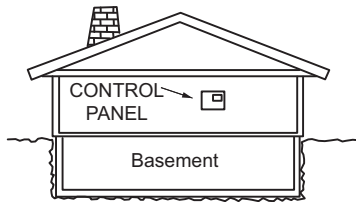

CORRECT
Mount Control Panel as HIGH
above earth level as practical



INCORRECT
Locating Control Panel below
earth level impairs range

Sensor Signal Loss Through Materials

90% - 100%
Of Full Power

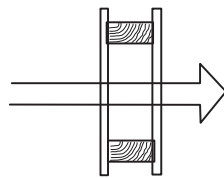

Wallboard and
Wood Studs

65% - 95%
Of Full Power

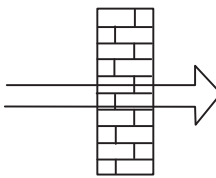

Light Concrete
Or Brick

10% - 70%
Of Full Power

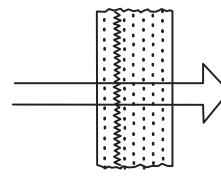

Concrete with Steel
Reinforcement or Metal
Lath and Plaster

Location of Sensors

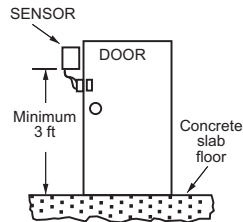

CORRECT

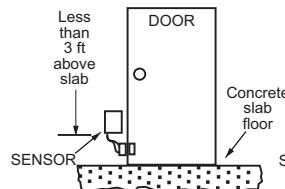

CORRECT

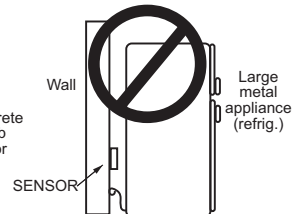

INCORRECT

Where to Place Burglary Protection Sensors

The following diagram shows a typical residential installation and the various types of wireless sensors and their function. Burglary Protection Sensors—Residential Installation

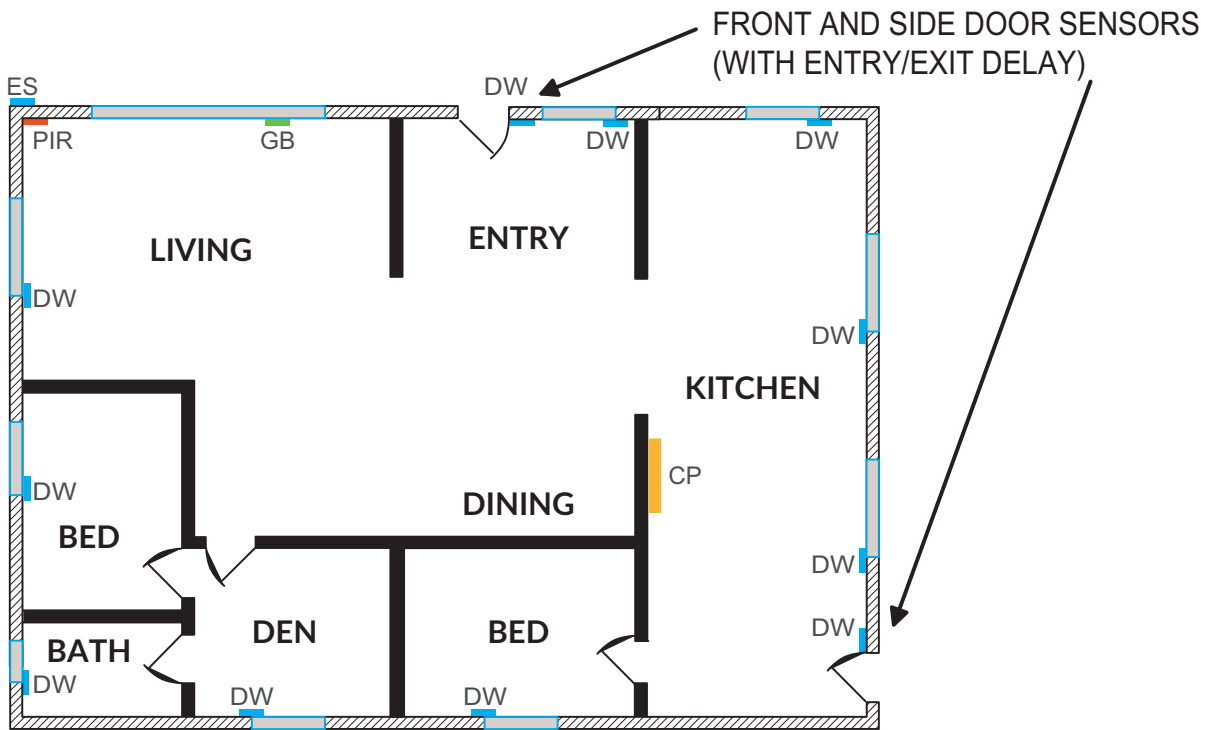

- CP - CONTROL PANEL
- DW - DOOR/WINDOW SENSOR
- PIR - MOTION DETECTOR
- GB - GLASS BREAK SENSOR
- PAD - WIRELESS KEYPAD
- ES - EXTERNAL SIREN

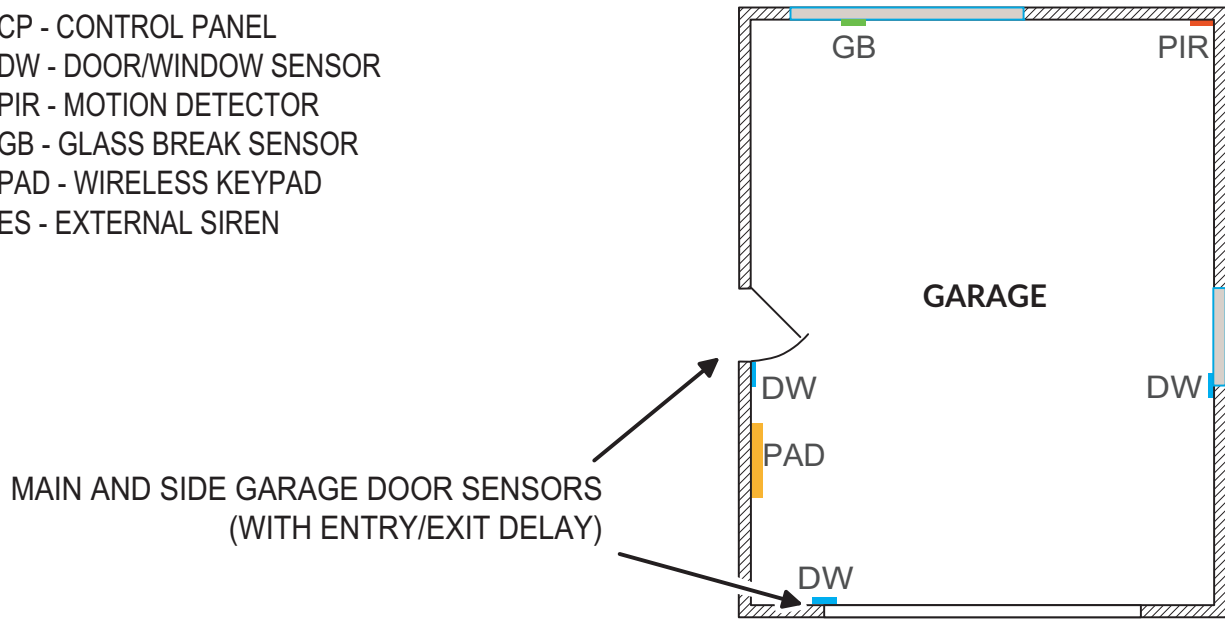

diag-gc3-burglary-floor-plan-en

Where to Place Fire Protection Sensors

IN THE UNITED STATES, CANADA, AND OTHER COUNTRIES REQUIRED TO MEET THIS STANDARD: THIS EQUIPMENT MUST BE INSTALLED IN ACCORDANCE WITH CHAPTER 2 of ANSI/NFPA 72: National Fire Alarm and Signaling Code (National Fire Protection Association, Batterymarch Park, Quincy, MA 02269).

Where NOT to Install a Smoke Alarm

- » Do NOT install a smoke alarm in a location where the normal ambient temperature is below 40°F (4.4°C) or higher than 100°F (37.8°C). Do NOT install a smoke alarm directly above a sink, shower, or bathtub.
- » Do NOT mount a smoke alarm next to a door or window affected by drafts. For example, do NOT install near an extractor fan or air vent. Do NOT mount a smoke alarm outside. The alarm is designed for indoor use only.
- » Do NOT mount a smoke alarm in or below a cupboard.
- » Do NOT mount a smoke alarm in a location where air flow is obstructed by curtains, furniture, or other items. Do NOT mount a smoke alarm where dirt, dust, or grease can collect and block the sensor.
- » Do NOT mount a smoke alarm where it can be knocked, damaged, or inadvertently removed.
- » Do NOT place any smoke alarm within 10 ft (3.04 m) of a kitchen appliance, furnace, water heater, or other source of combustion to minimize the risks of setting off a nuisance alarm.



Recommended Smoke Alarm Placement

Early warning fire detection is best achieved when fire detection equipment is installed in all rooms and areas of the premises. Equipment should be installed as follows:

Recommended Smoke Alarm Placement

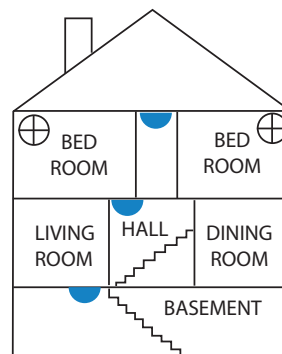
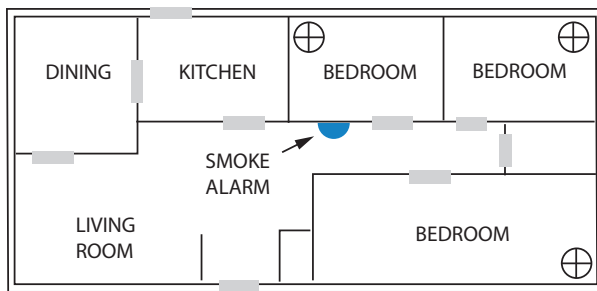
A A smoke alarm should be located between the sleeping area and the rest of the family living unit.



-  Indicates a required smoke alarm
-  Indicates an optional smoke alarm if door is not provided between living and recreation rooms
-  Indicates additional smoke alarms required for new construction

C A smoke alarm should be located on each story.

B In family living units with more than one (1) sleeping area, a smoke alarm should be provided to protect each sleeping area.

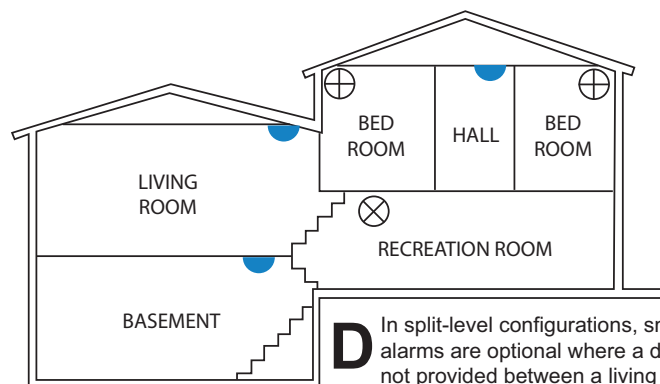
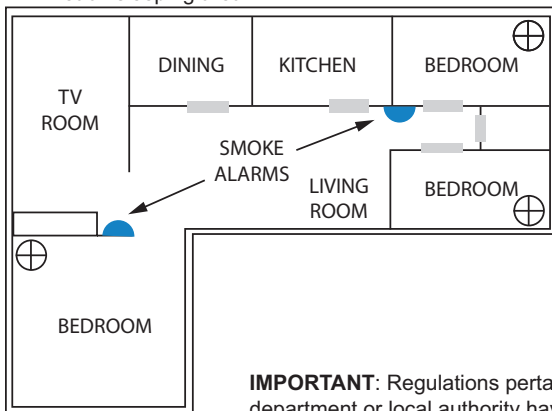

D In split-level configurations, smoke alarms are optional where a door is not provided between a living and recreation room.

IMPORTANT: Regulations pertaining to smoke alarm installations vary. For more information, contact your local fire department or local authority having jurisdiction.

Installation Steps

When installing the GC3 Security & Automation System, use the steps below as a general guideline. Before you begin, make sure that you have created the Installation Plan. See “Create the Installation Plan.”

- 1. Unpack the System:** Unpack the system and ensure you have all of the required tools and components.
- 2. Install the Cellular Radio Module:** Ensure the Cellular Radio Module is properly installed. Verify cell coverage with the proposed panel location in the home. See “Install the GC3 Cellular Radio Module.”
- 3. Mount the GC3 Panel’s Backplate:** If you will be mounting the GC3 Panel on the wall, identify the best location for the GC3 Panel near an unswitched power outlet. Then use the GC3 Panel’s backplate to mark the wiring cutout locations and mount the backplate to the wall. See “Mount the GC3 Panel’s Backplate.”

NOTE: If mounting the GC3 Panel on a wall is not an option, the 2GIG Desktop Kit can be purchased for use with the GC3 Security & Automation System. This is an accessory that lets one mount the GC3 Panel on a stand that can be placed on a flat surface, such as desk or counter. Use of this option may affect compliance with state or regional codes.

- 4. Connect an External Alarm Sounder:** If the property will be protected by an external alarm sounder, install the alarm sounder following the instructions provided with the sounder. Once installed, route the sounder’s wiring to the appropriate screw terminals on the GC3 Panel’s terminal block. See “Connect an External Alarm Sounder.”
- 5. Connect the Hardwire Loops:** If the property will be protected by any wired sensors, route the hardwire loop wiring to the appropriate screw terminals on the GC3 Panel’s terminal block. See “Connect the Hardwire Loops.”
- 6. Connect the Power Wires:** There are two methods of connecting power to the GC3 Panel. Connect the power cord using the barrel connector or connect a 2-conductor power wire (not supplied) to the appropriate screw terminals on the GC3 Panel’s terminal block. See “Connect the Power Wires.”
- 7. Connect the Backup Battery:** Before connecting the GC3 Panel to the AC power source, ensure the backup battery is connected. See “Connect the Backup Battery.”
- 8. Install the Wall Bracket and AC Power Supply:** After mounting the GC3 Panel on the wall, install the wall bracket and then plug in the AC Power Supply. See “Install the Retaining Wall Bracket and Connect the AC Power Supply.”
- 9. Install the Sensors and Peripheral Devices:** Follow the Installation Instructions included with each sensor and peripheral that you plan to install.
- 10. Program the Sensors & Peripherals:** Program the system’s wireless and wired zones, as well as any keyfobs or keypads. See “Programming Sensors & Peripherals.”
- 11. Complete the Panel Programming Steps:** Program settings for the GC3 Panel and the rest of the system. See “Panel Programming.”

Installing the System

Install the GC3 Cellular Radio Module

The 2GIG GC3 Cellular Radio Module is a snap-in unit providing the GC3 Security & Automation System with communication to the Central Station for alarm signaling and delivering (Over-the-Air) OTA firmware updates to the GC3 Panel. It also provides connectivity to the Remote Service Provider and 2-way voice communication. The module also includes a built-in antenna to provide a consistently strong communication signal.

The illustration below shows you the top view and bottom view of the GC3 Cellular Radio Module.

GC3 Cellular Radio Module—Top & Bottom View

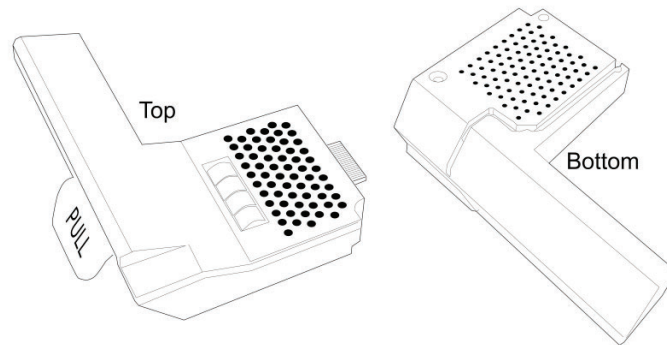

Install/Replace the Cellular Radio Module System Completely Powered OFF

To install/replace the Cellular Radio Module into a system that is completely powered OFF:

1. Remove the hinged door from the GC3 Control Panel.

Cellular Radio Module—Hinged Door

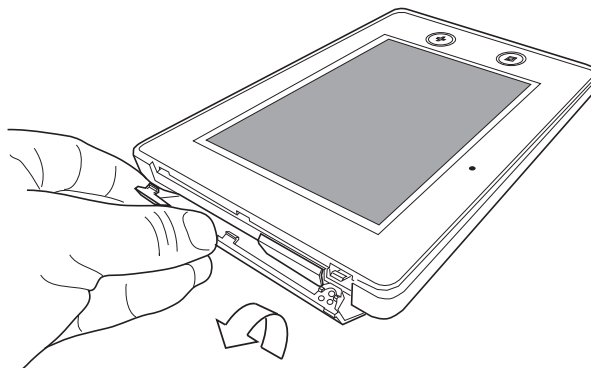

NOTE: If you are not able to remove the door, remove the door-lock screw for the Cellular Radio Module bay. See “(Optional) Lock/Unlock the Cellular Radio Module Door.”

2. If you are replacing a module, pull the tab to remove the Cellular Radio Module. Otherwise, skip this step and continue with step 3.
3. Insert the GC3 Cellular Radio Module until it clicks into place.
4. Replace the hinged door.
5. (Optional) Install the lock on the Cellular Radio Module bay door. See “(Optional) Lock/Unlock the Cellular Radio Module Door.”
6. Power up the system and wait for the Control Panel to recognize the Cell Radio Module. (This may take up to 5 minutes to complete.)
7. After installing the Cellular Radio Module, go to the **Installer Toolbox > System Configuration > Radio Test**. Then tap **Start Radio Test**. When the test reads “Success,” tap **Done**.

System Powered ON

To replace the Cellular Radio Module into a system that is powered ON:

1. From the Home screen, tap **System Settings**.
2. From the System Settings menu, tap **Cell Radio Swap**.



3. Tap **Begin**.
4. If the Cellular Radio Module bay is locked, remove the faceplate and then move the door-lock screw to the **UNLOCK** position. See “(Optional) Lock/Unlock the Cellular Radio Module Door.”
5. Remove the hinged door from the GC3 Control Panel.

Cellular Radio Module—Hinged Door

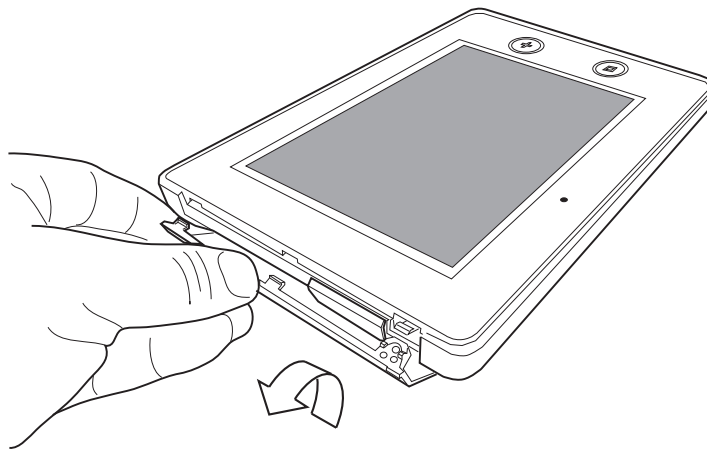

6. Pull the tab to remove the Cellular Radio Module.
7. Insert the GC3 Cellular Radio Module until it clicks into place.
8. (Optional) Install the lock on the Cellular Radio Module bay door.
9. Replace the hinged door.
10. Tap **Done**.

(Optional) Install the External Radio Module Antenna

To install the optional External Radio Module Antenna, follow these steps:

1. Disconnect the AC power supply from the power source.
2. Remove the Control Panel from the backplate and secure the panel with the Third Hand Hanging Strap
3. Disconnect the battery from the Control Panel.
4. If the Cellular Radio Module is already installed, remove the hinged door from the GC3 Control Panel and pull the tab to remove the Cellular Radio Module. Otherwise, skip this step and continue with step 5.
5. Remove the three (3) screws that secure the Cellular Radio Module cover and remove the cover.

Cellular Radio Module—Remove Cover

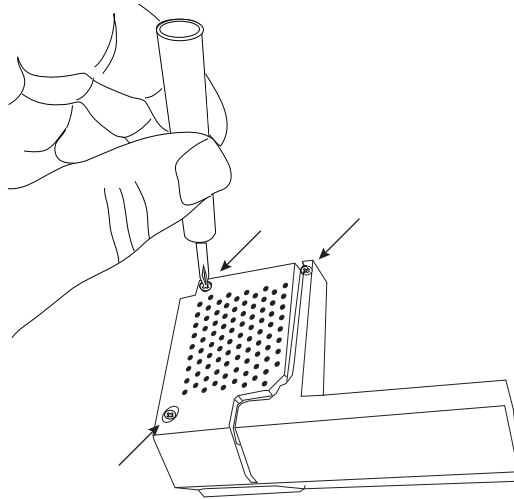

6. Disconnect the antenna from the Cell Radio Module PCB and remove the antenna.
7. Connect the external antenna to the Cell Radio Module PCB.

Cellular Radio Module—Route Antenna Cable

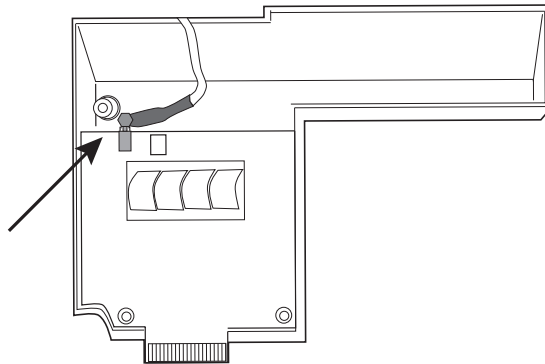

8. Route the external antenna cable out through the slot on the bottom of the module.
9. Replace the Cellular Radio Module cover and secure with the three screws.
10. Secure the antenna cable within the channel on the bottom of the module.
11. Route the external antenna into the Control Panel and insert the Cellular Radio Module into the Control Panel until it clicks into place.
12. Route the antenna cable through the wiring cutout on the GC3 Control Panel's backplate.
13. Connect the battery to the Control Panel.
14. Mount the Control Panel on the backplate.
15. Connect the AC power supply to the power source.

(Optional) Install the External Attic Mount Cellular Radio Module Antenna

If you will be installing the optional External Attic Mount Cellular Radio Module Antenna, follow these steps:

1. Mount the antenna plate as high as possible on a wall or in the attic.
2. Drop the antenna's 10-foot cable down to the GC3 Panel.

External Attic Mount Cellular Radio Module Antenna

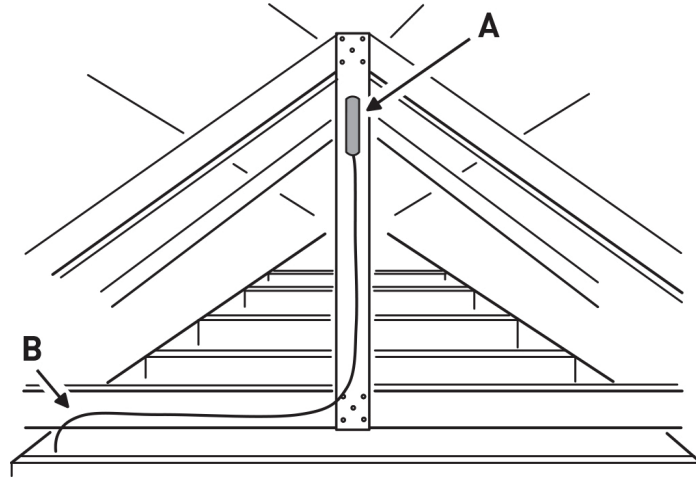

3. Route the antenna cable through the wiring cutout on the GC3 Panel's backplate.
4. Route the antenna cable and attach it to the connector on the Cellular Radio Module.

(Optional) Lock/Unlock the Cellular Radio Module Door

The Cellular Radio Module fits into the bay on the side of the GC3 Panel and features a built-in door lock under the faceplate. The Control Panel ships with the door-lock screw in the UNLOCK position. To limit the possibility of someone removing the door, installers have the option of moving the screw to the LOCK position.

GC3 Cellular Radio Module Door Lock

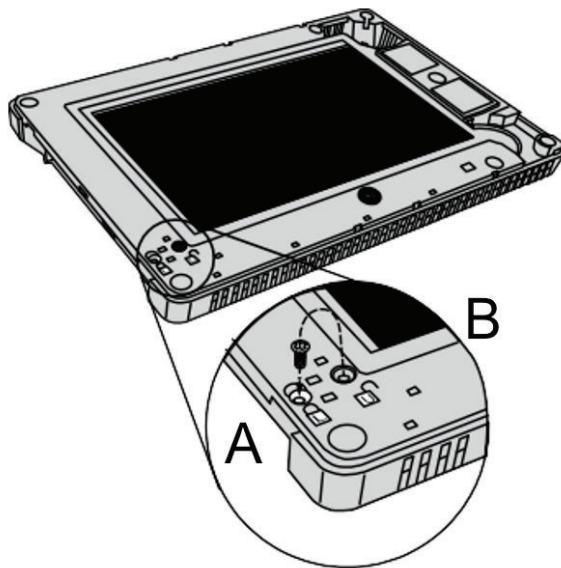

To lock and unlock the Cellular Radio Module door:

1. Use your fingertips or carefully insert a screwdriver at the edge of the faceplate. Then gently pry the faceplate from the chassis.

GC3 Panel—Removeable Faceplate

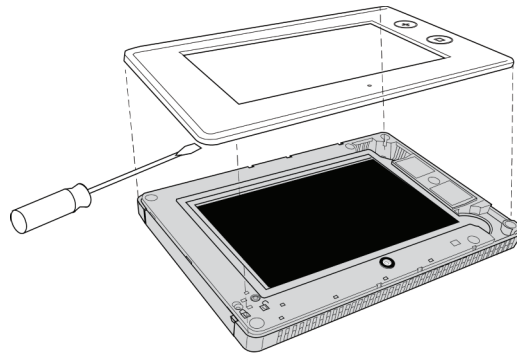

2. Remove the door-lock screw from the UNLOCK position on the right.

GC3 Panel—UNLOCK position

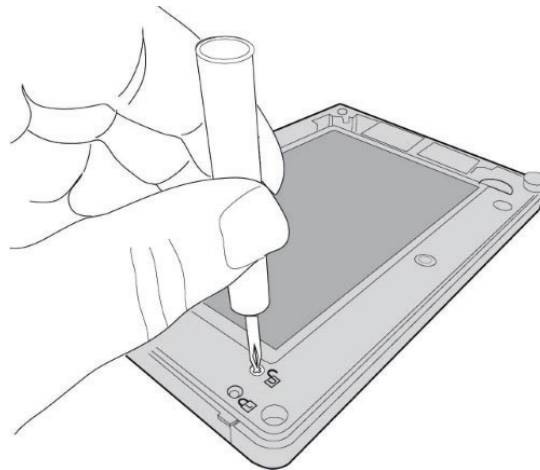

3. Install the screw into the LOCK position on the left. This locks the hinged door on the GC3 Control Panel.

GC3 Panel—LOCK position

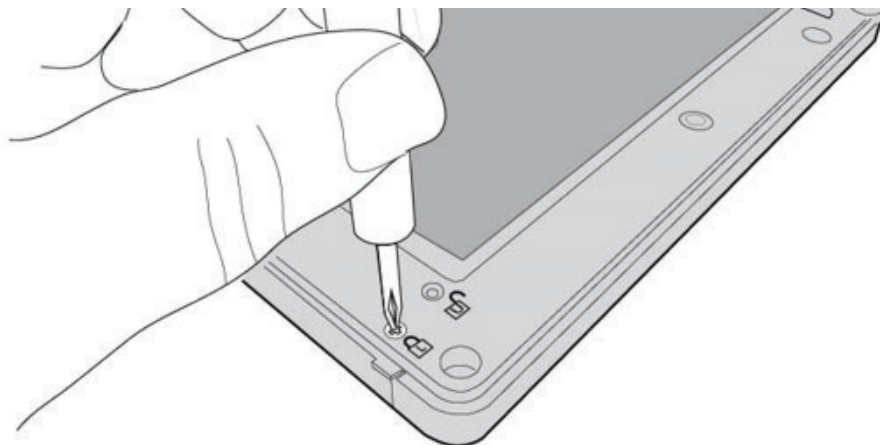

4. Snap the faceplate back on the GC3 Control Panel. Mount the GC3 Panel's Backplate

Mount the GC3 Panel's Backplate

Before mounting the GC3 Panel in its permanent location, use the guidelines below to choose the placement. Also ensure you have the recommended tools and equipment. See “Recommended Tools and Equipment.”

Choose the Wall Location

To choose a wall location for the GC3 Panel, see “Where to Mount the GC3 Panel.”

Mount the Backplate to a Wall

To mount the backplate to a wall:

1. Position the GC3 Panel at the desired location on the wall.
2. Insert a pencil into the placement feature on the top of the panel and make a mark in the reference groove.
3. Loosen the locking screw on the bottom of the GC3 Panel. This allows the backplate to be removed from the rest of the chassis.

NOTE: The locking screw cannot be removed from the panel. Do not use excessive force to remove the captive screw from the case.

GC3 Panel Backplate—Nonremovable Locking Screw

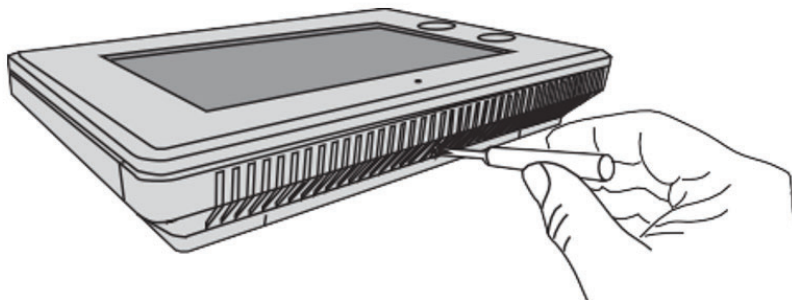

4. Separate the backplate from the GC3 Panel. The backplate hinge is located on the top of the panel. Remove the bottom of the backplate first.
5. Press the backplate flush against the wall at the mounting location.

NOTE: The backplate has a built-in level to ensure the GC3 Panel hangs straight.

GC3 Panel—Built-in Level

6. Use the backplate as a template to mark the location of the wiring cutout. Then cut a slot in the dry wall for the AC power cord and other electrical wiring (if needed).

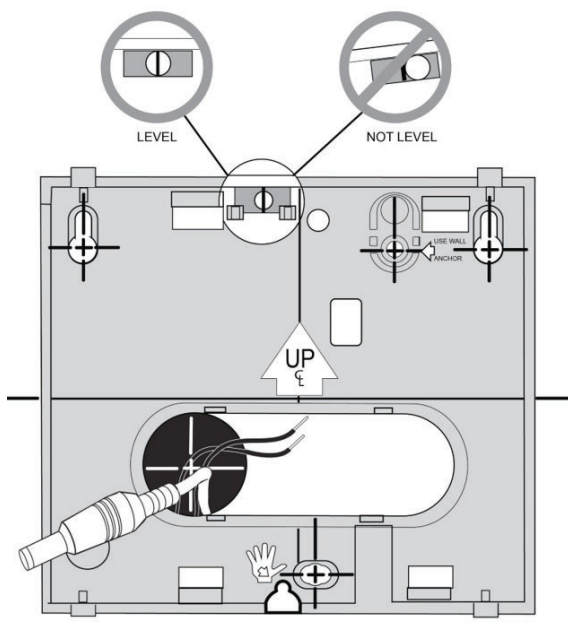

7. Route the barrel connector for the power supply or 2-conductor wire (if connecting power to the GC3 Panel's terminal block) through the wiring cutout.

8. If you are installing any hardwire loops, an external alarm sounder, an external in-wall antenna, or open collector outputs that must be connected to the GC3 Panel's terminal block, route those wires through the cutout.

WARNING!! To avoid serious injury or death while wiring the terminal block connections, do NOT connect the GC3 Panel's power supply to a power source and always ensure that you disconnect the backup battery before servicing the panel's internal components.

9. Attach the backplate to the wall using the four (4) wall anchors and screws (supplied). The center top screw is the wall tamper and MUST have an anchor to work.

10. Attach the backplate to the wall using the four (4) wall anchors and screws (supplied). The center top screw is the wall tamper and **MUST** have an anchor to work.

GC3 Panel—Backplate Installation

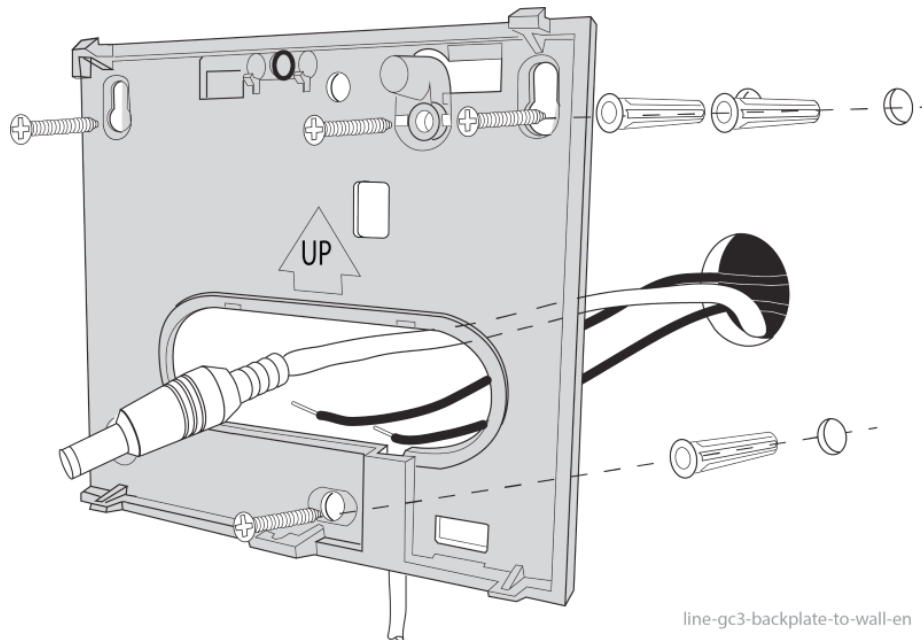

NOTE: If you are upgrading the control panel from the previous version, you can reuse the two (2) GC2 mounting screws.

11. Attach the GC3 Panel's third-hand hanging strap to the hook at the bottom of the backplate. Optional Desktop Kit

Optional Desktop Kit

NOTE: If mounting the GC3 Panel on a wall is not an option, the 2GIG Desktop Kit can be purchased for use with the GC3 Security & Automation System. This is an accessory that lets one mount the GC3 Panel on a stand that can be placed on a flat surface, such as desk or counter. Use of this option may affect compliance with state or regional codes.

Optional 2GIG Desktop Kit—Rear View

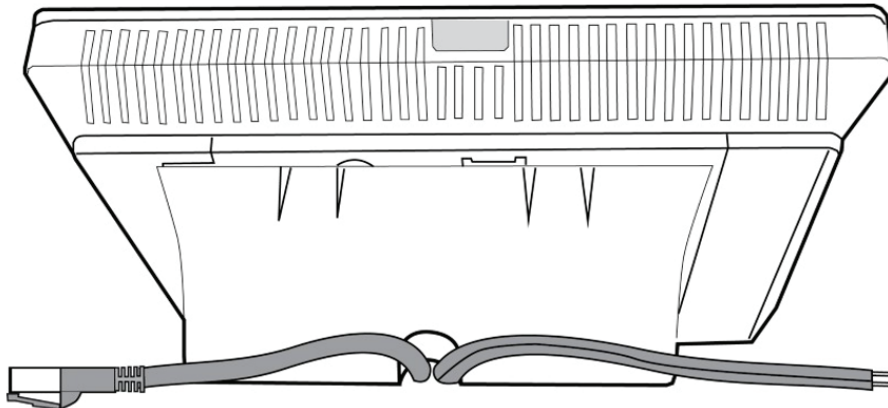

Connect an External Alarm Sounder

The terminal block inside the GC3 Panel includes two (2) solid-state bell terminals (BELL+/BELL-) for an external alarm sounder. An external alarm sounder is typically housed outside of a property, in a location that will attract the most attention, in order to scare unwanted intruders away with an audible alarm (and sometimes also a strobe light). When choosing a location for the sounder, ensure it is protected from harsh weather (either housed indoors or in a weatherproof box). It should also be mounted in a location where the siren can be easily heard by occupants.

- » **If you are installing a new external sounder:** First, install the external sounder in the desired location. Then route the wiring to the GC3 Panel's terminal block.
- » **If you are replacing an existing external sounder:** First, install the replacement sounder in the desired location. Then route the wiring to the GC3 Panel's terminal block.
- » **If an external sounder is already installed:** First, disconnect power to the external sounder. Then route the sounder's existing wiring to the GC3 Panel's terminal block.

IMPORTANT: The GC3 Panel is designed to connect to Solid-State Relay sounders only. To avoid damage to the output, do NOT connect an Electromechanical Relay bell to the BELL+ or BELL- position on the GC3 Panel's terminal block. In addition, bell output is only provided when the GC3 Panel's power supply is connected to an AC power source.

To connect an external alarm sounder to the GC3 Panel:

1. Install the sounder in a secure, weatherproof location where it can be easily heard.
2. Disconnect the sounder from its power source.
3. Ensure the GC3 Panel is disconnected from both the AC power source and the backup battery.
4. Route the wiring from the sounder through the back of the GC3 Panel's wiring cutout.
5. Connect the sounder's wires to the BELL+ and BELL- positions on the GC3 Panel's terminal block.

NOTE: For sounders with low current consumption, low current relays, or in the event that the Piezo Sounder produces a humming sound or noise, install an 820Ω resistor in parallel with the sounder.

Wiring Diagram—Bell Output

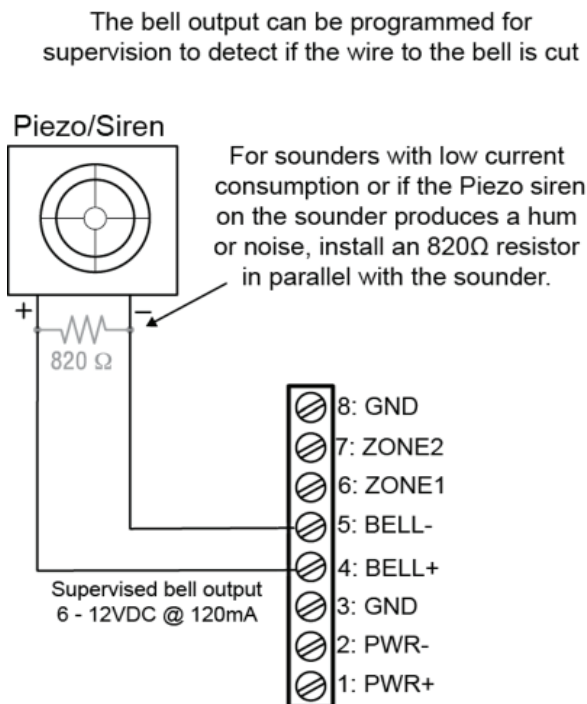

TIP: After the installation is complete, navigate to the **Panel Programming** menu to configure siren supervision. This lets the system notify both the user and the Central Station if the wire between the external alarm sounder and GC3 Panel is cut. By default, this setting is turned OFF. See "Q28: Siren supervision time."

Use Solid State Sounders ONLY
Do NOT connect to an electromechanical bell

Connect the Hardwire Loops

The GC3 Panel supports up to two (2) wired zones. Typically, these zones are used for hardwired Door/Window contact sensors. You first install the contact sensors and then route the loop wiring to the GC3 Panel. This type of connection is commonly referred to as hardwire loops.

IMPORTANT: The GC3 Panel's hardwire loops are designed to support contact sensors such as magnetic reed switches or pressure pads. They are not designed for hardwire smoke detectors, carbon monoxide detectors, motion detectors, or glass break detectors.

TIP: If you are planning to upgrade the existing wired security system at the home or business to a wireless system or if you have a need to retrofit any pre-wired sensors in newer construction for wireless, you can purchase the 2GIG Hardwire Conversion Kit (2GIG-TAKE-KIT1) .

To install the hardwire loop wiring for the contact sensors:

1. Install the wired contact sensors.
 2. Route the contact sensor's loop wire(s) through the back of the GC3 Panel's wiring cutout.
 3. Use the diagram below as a guide for connecting the sensor's loop wires to the GC3 Panel terminal block.
- » **Normally Closed (N/C):** Used for Normally Closed (N/C) circuits. This means the circuit on the contact switch is closed when the magnets are aligned on the door/window contact. When armed, the GC3 Panel activates an alarm signal it detects that the door or window is no longer in the normally closed state.
 - » **Normally Open (N/O):** Used for Normally Open (N/O) circuits. This means the circuit on the contact switch is open when the magnets are aligned on the door/window contact. When armed, the GC3 Panel activates an alarm signal when it detects that the door or window is no longer in the normally open state.
 - » **End-of-Line Resistor (EOLR):** Used to supervise the sensor for open or short circuit conditions with an End-of-Line Resistor (EOLR). If EOLR supervision is required, you must install a 2.2 kΩ resistor (not supplied). End of Line Resistors must be installed at the location in the loop farthest away from the panel. This feature allow for the use of an EOL resistor for existing zones.

NOTE: For compliance with UL 38: Manual Signaling Boxes for Fire Alarm Systems, stranded conductors clamped under wire binding screws or similar parts shall have the individual strands soldered together or shall be equivalently arranged.

Wiring Diagram—Hardwire Loops

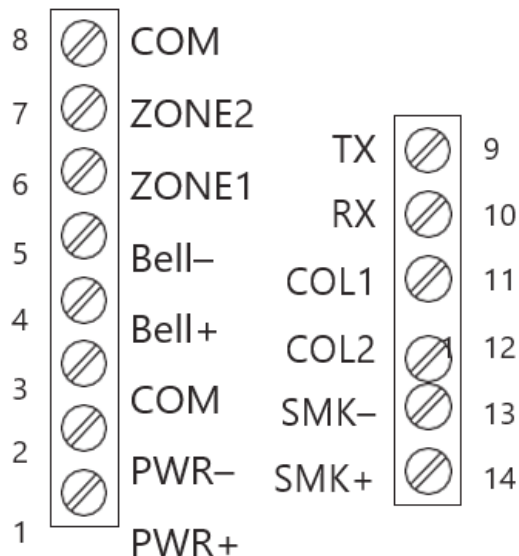

TIP: After the installation is complete, you must program the wired zone into the GC3 Panel. During programming, you must define the normal state of the circuit for each wired zone. See "Program a Wired Zone."

Connect the Power Wires

There are two ways to connect the wires for the power supply to the GC3 Panel:

- 1. Terminal Block:** Securely fasten a 2-conductor power wire (not supplied) to the appropriate PWR+/PWR- screw positions on the GC3 Panel's terminal block.
- 2. Barrel Connector:** A plug-in power supply with a barrel connector can be plugged into the DC power adapter's barrel jack on the GC3 Panel.

IMPORTANT: When selecting a wall outlet, never connect the plug-in power supply to a switch-controlled outlet.

Maximum Wire Gauge and Length

American Wire Gauge (AWG)	Maximum Length (feet)	Maximum Length (meters)
22 AWG	50	16.8
20 AWG	80	25.9
22 AWG 2-pairs (19 AWG equivalent)	110	33.5
18 AWG	125	41.1

Terminal Block

The most common way to connect the AC power supply for the GC3 Panel is to use the system's terminal block. This requires you securely fasten 2-conductor power wire (not supplied) to the appropriate PWR+/PWR- screw terminals.

GC3 Panel—Terminal Block

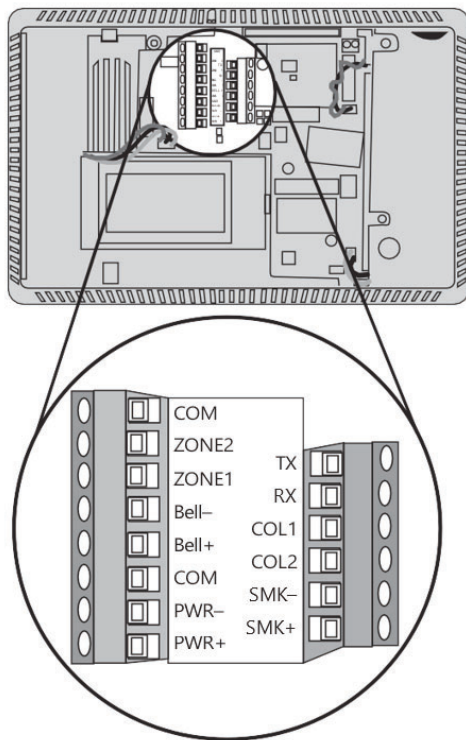

To connect the power supply to the GC3 Panel:

1. Locate an unswitched wall outlet for the plug-in power supply. Do NOT connect the power supply to the outlet at this time.
2. Route 2-conductor power wire from the plug-in power supply through the wiring cutout on the GC3 Panel's backplate. See "Connect the Power Wires" above.

WARNING!! The proper wiring sequence for the DC power supply terminal block is always ground to ground, positive to positive, and negative to negative. However, grounding the GC3 Panel is NOT required for proper operations.

3. Insert the positive wire into the PWR+ terminal position. Then tighten the terminal block's contact screw.

IMPORTANT: Do not over-tighten the terminal block's contact screws.

NOTE: Terminal 1 only provides power for the GC3 Panel when its power supply is connected to an AC power source.

5. Insert the negative wire into the PWR- terminal position. Then tighten the terminal block's contact screw.

GC3 Panel—Terminal Block Power

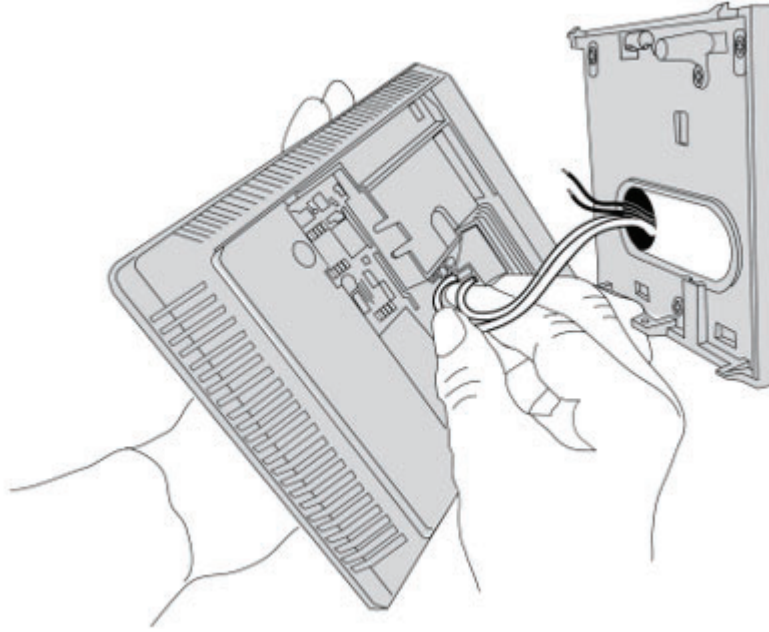

WARNING!! Do NOT plug the power supply into the outlet at this time. Always complete all system wiring and then secure the backplate to the GC3 Panel before connecting its power supply to the outlet.

Barrel Connector

An alternate method for connecting the AC power supply for the GC3 Panel is to use the optional barrel connector.

To connect the power supply's barrel connector to the GC3 Panel:

1. Locate an unswitched wall outlet for the plug-in power supply. Do NOT connect the power supply to the outlet at this time.
2. Route the power wire from the plug-in power supply through the wiring cutout on the GC3 Panel's backplate.
3. Plug the barrel connector into the DC power adapter barrel jack on the back of the GC3 Panel.

GC3 Panel—Barrel Connector to DC Power Jack

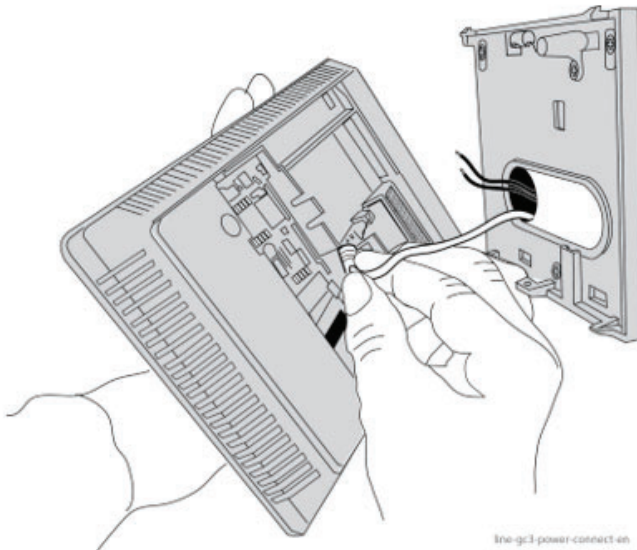

WARNING!! Do NOT plug the power supply into the outlet at this time. Always complete all system wiring and then secure the backplate to the GC3 Panel before connecting its power supply to the outlet.

Control Panel Wiring Diagram

The following diagram shows the Control Panel wiring.

Control Panel Wiring Diagram

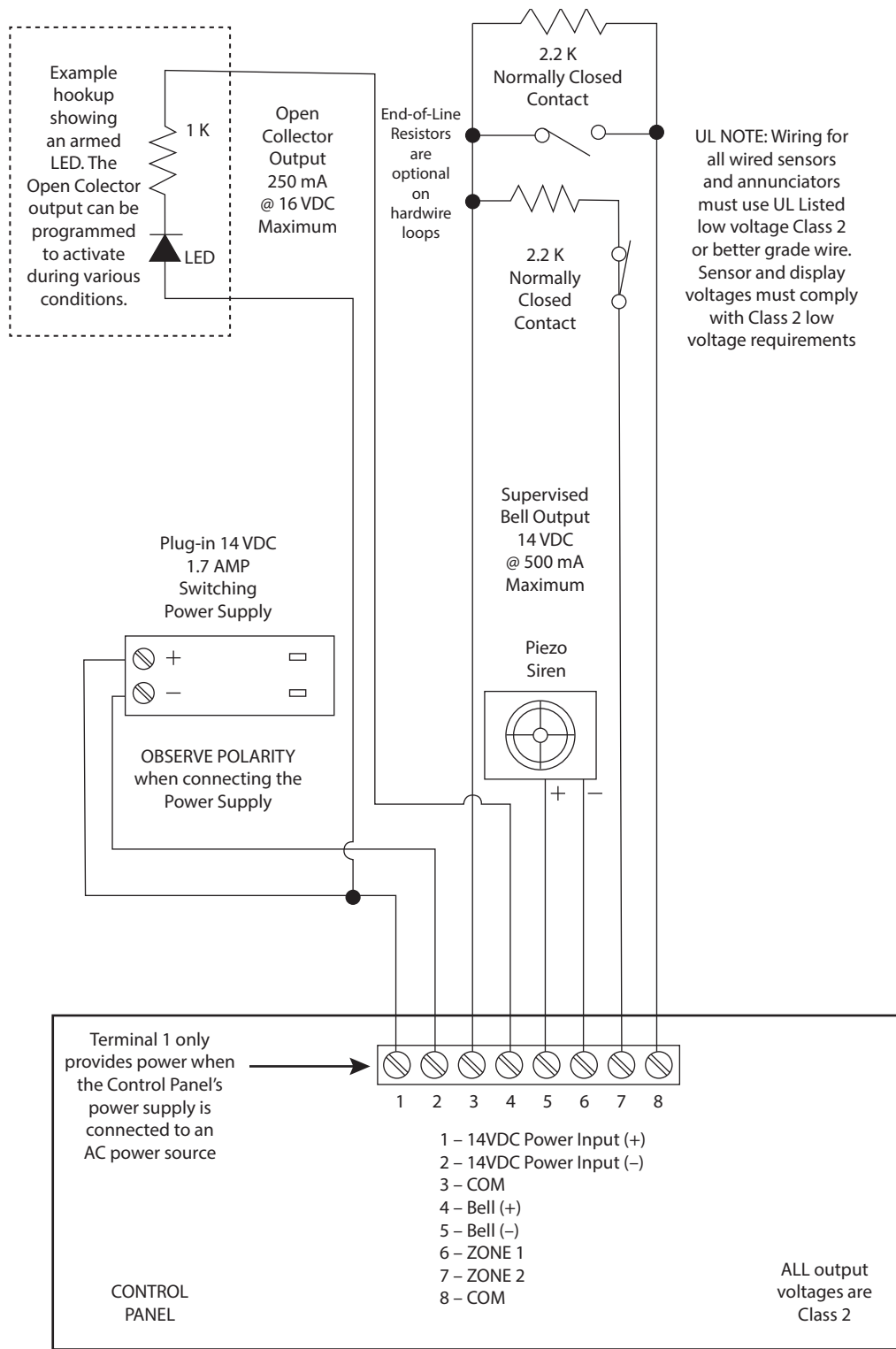

Terminal Blocks Wiring Diagram

The GC3 Panel includes an 8-position terminal block and a 6-position terminal block. The table below describes each position on the terminal blocks.

*Terminal Block Positions**

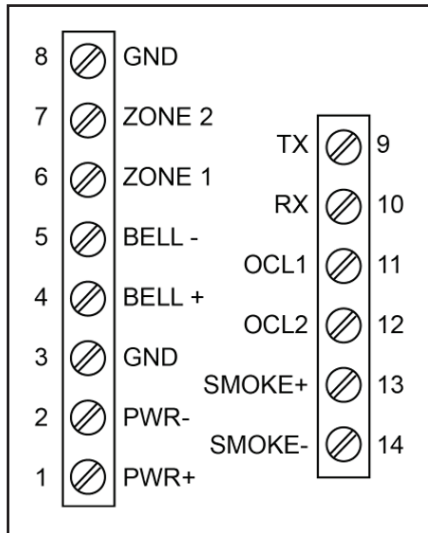

Position	Label	Output Voltage	Maximum Length (meters)
1		CLASS 2	14 VDC Power Input (+). Only provides power when the GC3Panel's power supply is connected to an AC power source.
2		CLASS 2	14 VDC Power Input (-)
3		CLASS 2	Ground (Low Side Hardwire Zone)
4		CLASS 2	Bell +
5		CLASS 2	Bell -
6		CLASS 2	Hardwire Loop Zone 1
7		CLASS 2	Hardwire Loop Zone 2
8		CLASS 2	Ground (Lowside Hardwire Zone)
9*		CLASS 2	Transmit (RS232 TX) (Image Sensor)
10*		CLASS 2	Receive (RS232 RX) (Image Sensor)
11		CLASS 2	Open Collector Output 1
12		CLASS 2	Open Collector Output 2
13		CLASS 2	(+) Image Sensor
14		CLASS 2	Not supported

Connect the Backup Battery

After connecting or wiring the DC power supply on the panel, use these steps to connect the backup battery.

To connect the backup battery:

1. Ensure the backup battery is properly seated in the GC3 chassis. The battery's label should be facing up and the battery's connector wire should be on the left with the wire running in the empty space between the battery compartment and Cellular Radio Module's compartment
2. Insert the wired battery pin into the PCB battery connector. The connector is located directly behind the DC power adapter barrel jack.

GC3 Panel—Backup Battery Connector

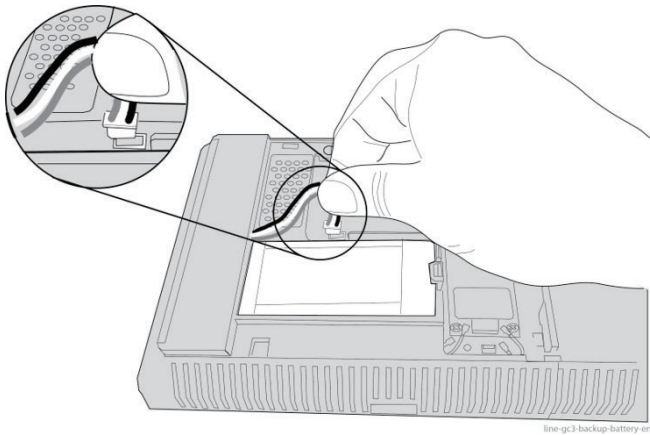

Important: The GC3 Panel will not recognize the backup battery connection until you plug the AC power supply into the wall outlet.

Warning!!: Do NOT plug the power supply into the outlet at this time. Always complete all system wiring and then secure the backplate to the GC3 Panel before connecting its power supply to the outlet.

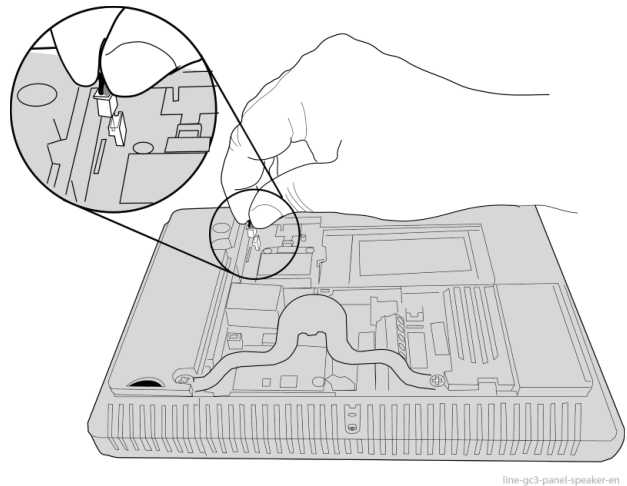

Hang the GC3 Panel

To hang the GC3 Panel on the mounting plate:

1. Ensure all installed wiring is securely fastened.
2. Ensure the connector to the Piezo Sounder is secure.

GC3 Panel—Internal Siren/Speaker Connector

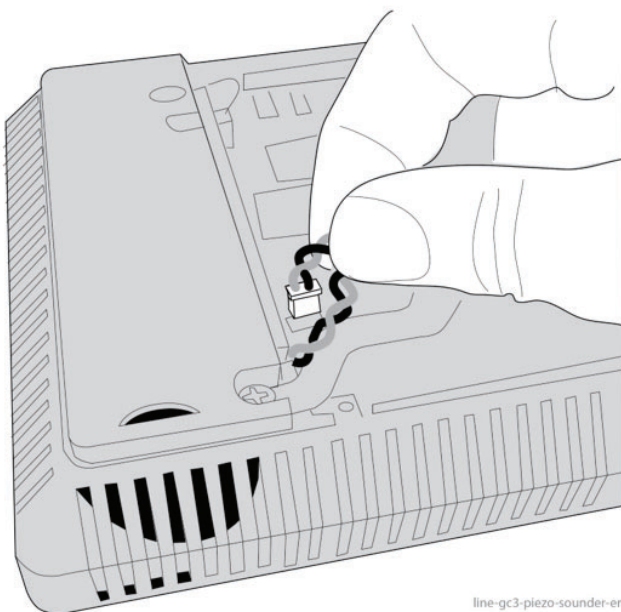

3. Ensure the connector to the internal siren/speaker is secure.

4. Place the backplate over the lower lip on the back of the chassis and flip the GC3 Panel upwards.

5. Push the GC3 Panel over the mounting bracket until it clicks into place.

Note: Continue with the next step in the section that follows titled, "Install the Retaining Wall Bracket and Connect the AC Power Supply."

Ethernet Module Installation (Optional)

An Ethernet module can be added to the GC3 Panel to allow a hardware network connection to the system.

Note: Only a single broadband is available on the GC3 panel at any time. If a hardwired connection is active on the GC3 the WiFi connection will be disabled.

Install the Retaining Wall Bracket and Connect the AC Power Supply

After you have completed all of the required system wiring and connected the battery backup, install the wall bracket and connect the AC power supply to the wall receptacle.

Note: When power is initially applied to the panel it should not be face down. In addition, do not touch the panel buttons until after the panel is powered up.

Note: For compliance with ANSI/NFPA 70: National Electric Code in the United States, you must install the power supply retaining bracket. Use of the power supply retaining bracket is not required in Canada.

To install the wall bracket and connect the AC power supply:

1. Locate an unswitched wall outlet for the plug-in power supply. Do NOT connect the power supply to the receptacle.
2. Peel the adhesive backing off the power supply's retaining wall bracket and attach it to the receptacle.
3. Secure the bracket to the wall using the fastening screw.
4. Spread the ears of the retaining bracket apart. Then plug the power supply into the outlet.

Retaining Wall Bracket—Standard-Style Duplex Receptacle

Retaining Wall Bracket—Decora-Style Duplex Receptacle

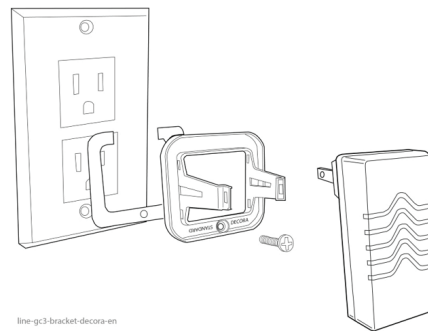
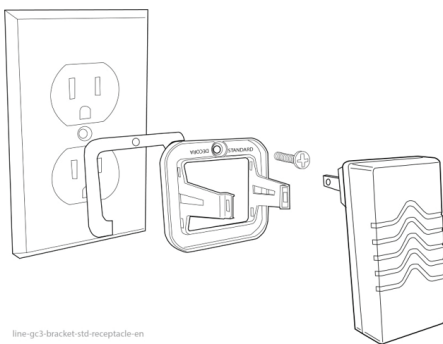

5. Thread zip ties through the slots on the power supply and fasten them securely.

Wall Bracket Zip Tie—Standard-Style Duplex Receptacle

Wall Bracket Zip Tie—Decora-Style Duplex Receptacle

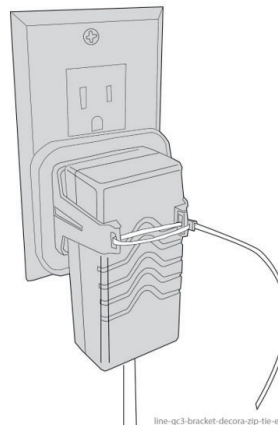
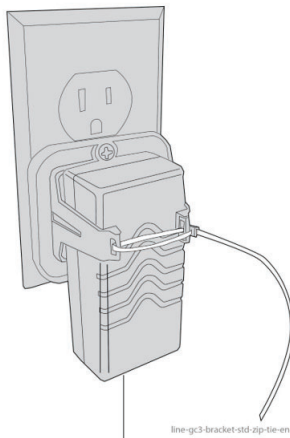

With the installation complete, you can begin programming sensors and peripherals for use with the GC3 Panel. See “Programming Sensors & Peripherals.”

Update the GC3 Panel Firmware

As 2GIG releases firmware updates for the GC3 Panel, download the update to a USB thumb drive and then connect it to the USB port on the GC3 Panel.

To update the firmware:

1. Download the latest firmware update from dealer.2gig.com.
2. Copy the firmware update to a USB thumb drive (not supplied).

Note: The USB thumb drive must be FAT/FAT32 formatted. The system will not read an NTFS formatted thumb drive.

3. Remove the USB protector from the USB port on the top of the GC3 Panel.

GC3 Panel—USB Protector



4. Insert a thumb drive storing the desired firmware version into the USB port at the top of the GC3 Panel.

GC3 Panel—USB Port

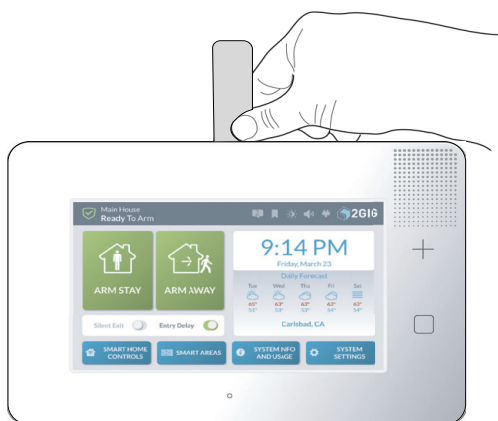

The **Firmware Update** icon appears in the **Status Icons** area and the **Firmware Update Available from USB Device** message appears.

5. Tap Update.

Firmware Update Available from USB Device

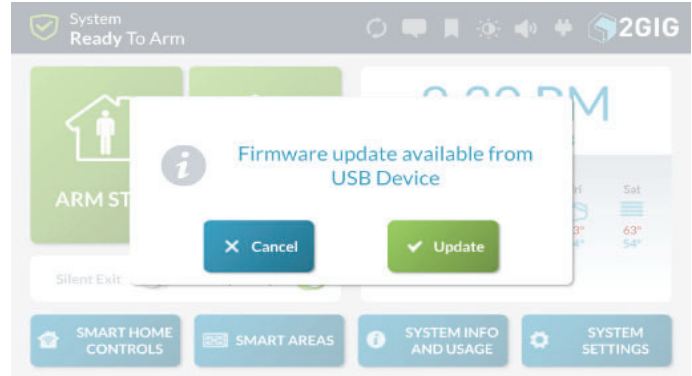

Note: Firmware Update Available from USB Device message appears for approximately 10 seconds. If you are not able to tap the **Update** button in the message in that time, you can alternately tap the **System Settings** button or the **Firmware Update** button in the system icons area. Then enter the Master User Code, and then tap **Firmware Update** to start the update process.

The GC3 Panel turns BLACK and in a few moments, the **Updating Firmware** message appears.

Important: During the update process, do NOT disconnect the GC3 Panel from its power source and do NOT remove the USB thumb drive until the update is complete.

When complete, the system restarts automatically and a new message appears in the system's Inbox to notify users that the firmware update was successful.

6. On the Home screen, tap the Inbox system icon. Then tap **Messages**.

Inbox Messages - Update with Areas on Control Panel Illustration

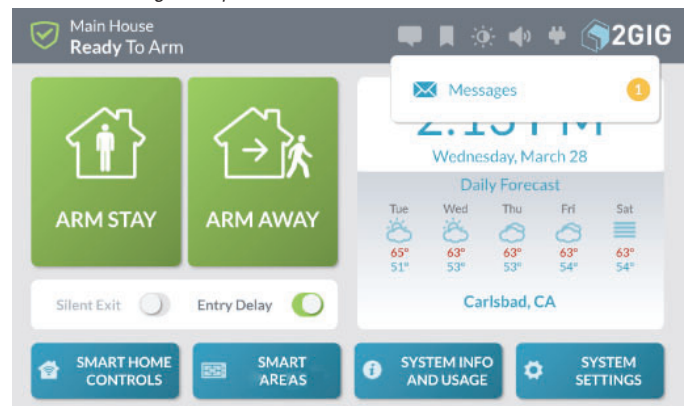

On the **Messages** screen, tap the **GoControl Firmware Update** message.

7. On the **Messages** screen, tap the **GoControl Firmware Update** message.

Messages

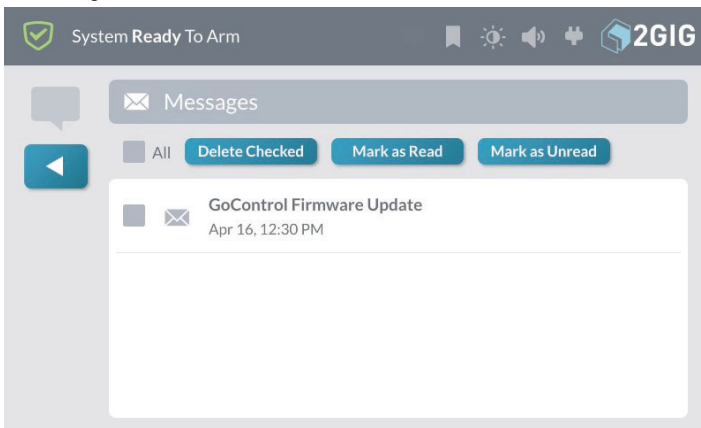

8. Review the message as needed. Then tap **Delete**, **Mark as Read**, or **Mark as Unread** as desired.

New Message

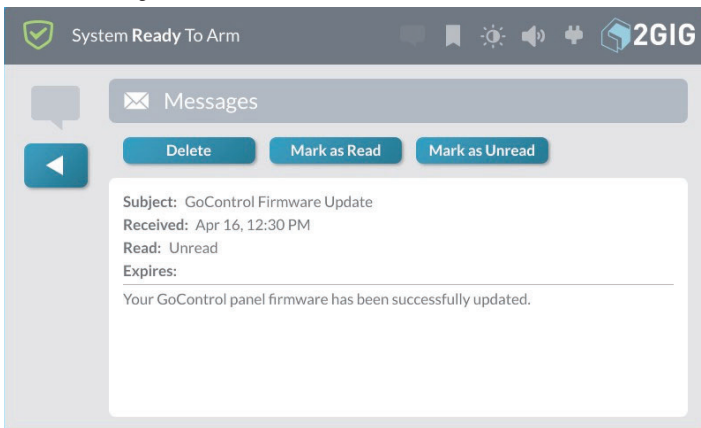

Navigate to the Installer Toolbox

When installing sensors and peripherals for use with system, refer to the *Installation Instructions* included with each product. Once you know where you will install the sensors, you can program them for use with the GC3 Panel. To do this, use the **Installer Toolbox** menu.

The **Installer Toolbox** is the primary menu used by 2GIG alarm dealers and professional installers. It provides these users with access to system and peripheral programming functions for the GC3 Security & Automation System. There are two (2) ways to navigate to the **Installer Toolbox** menu. Use the system logo in the top-right corner of the Home screen (or a menu) or access it from the **System Settings** menu.

Note: To use this feature, you must enter the Installer Code. The factory default setting is 1561.

To navigate to the Installer Toolbox:

- » At the Home screen or one of the menus, tap the logo in the top-right corner. Then enter your code to access the Installer Toolbox.
- OR
- » At the Home screen, tap System Settings. Then, enter your code and tap Installer Toolbox.

Navigate to the Installer Toolbox Menu

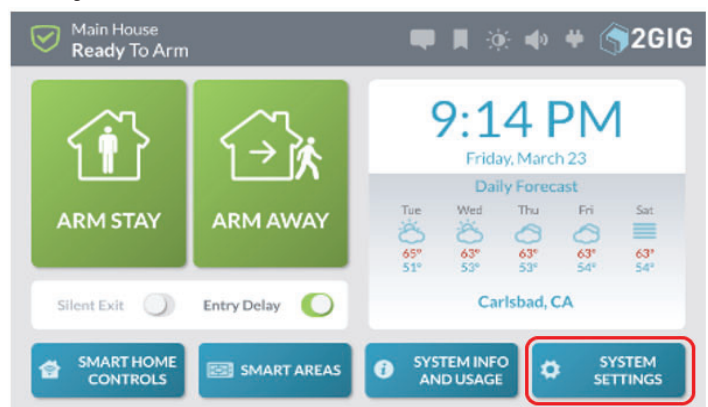

The **Installer Toolbox** menu is shown below.

Installer Toolbox Window

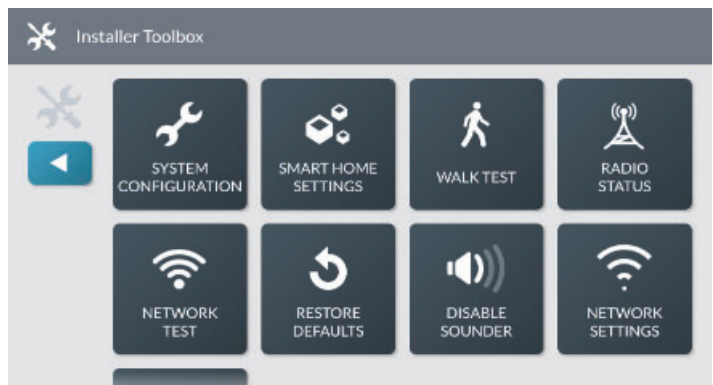

Broadband

The built-in WiFi module and optional Ethernet module allow for broadband connection for dual-path communication, OTA updates, and connection with secondary keypads.

Dual Path

Dual path communication is enabled by the backend provider if available and allows for 2-way communications between the panel and backend over broadband (WiFi or Ethernet) with the cell radio as a second path of communication.

Note: 2-way voice communication is available by cell radio only.

OTA

“Over the Air” updates by broadband are supported for firmware v.3.1.0+, and High-Speed OTA is supported for firmware v.3.1.3+. Check with your backend provider about discounted pricing for OTA over broadband.

Secondary Keypads

Broadband is also used for connection of secondary keypads (SP1 and SP2). Keypads can be connected to the same client WiFi as the main panel or to the systems internal Access Point. See the section “Access Point.”

Attaching to a Wireless Network

Attach to a Wireless Network

1. Navigate to Installer Toolbox menu and tap **Network Settings**.

Installer Toolbox



2. Tap **Wireless**.

Wireless Selection



A list of available networks will be displayed.

3. Tap **Network** to connect to.

Select Wireless Network

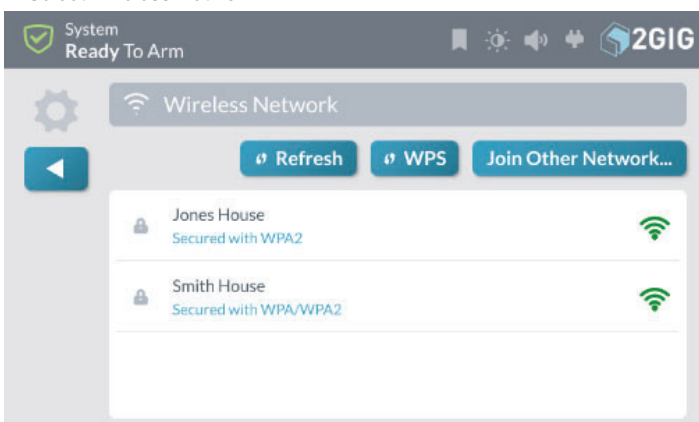

4. Enter network password and tap **Next**.

Keyboard Entry Screen

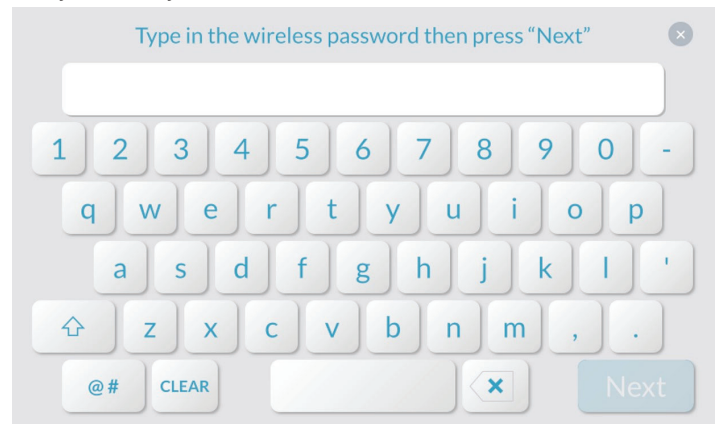

You will see the IP Address and other network information.

Wireless Network Setup

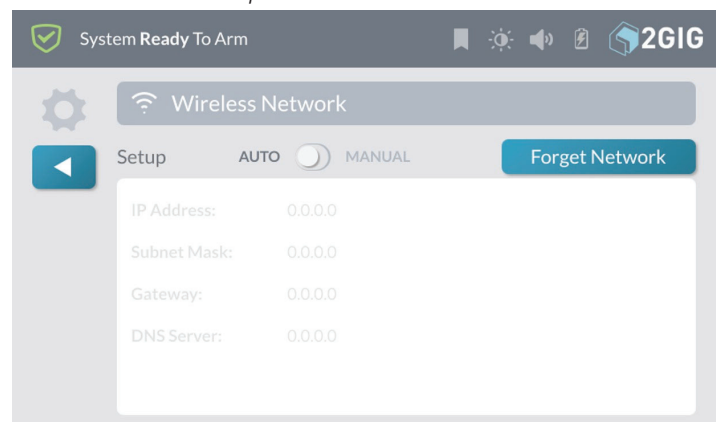

Note: This WiFi connection only connects the panel to the local network. WiFi is required for connecting wireless touchscreens to the GC3 Panel.

Selection Buttons

Refresh

Network Options

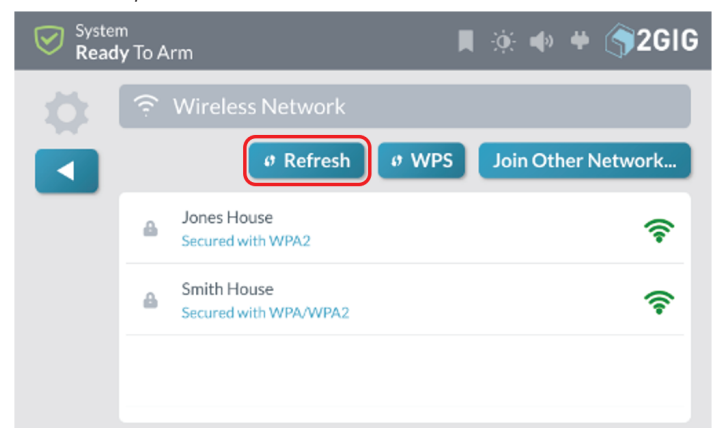

Tapping **Refresh** will refresh the list of available networks.

WPS

Tapping **WPS** allows you to connect securely to routers that support WPS.

1. Tap **WPS** on GC3 Panel.

WPS Button

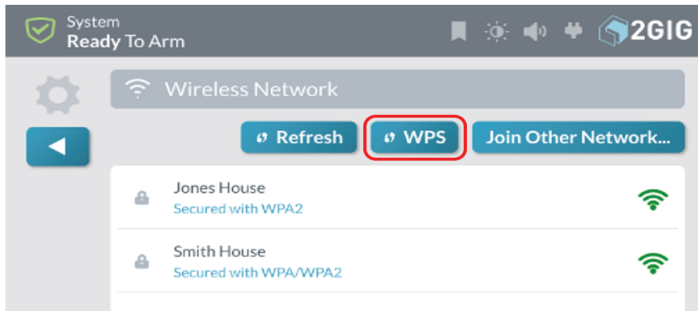

2. Tap **Connect**.

Connect Button

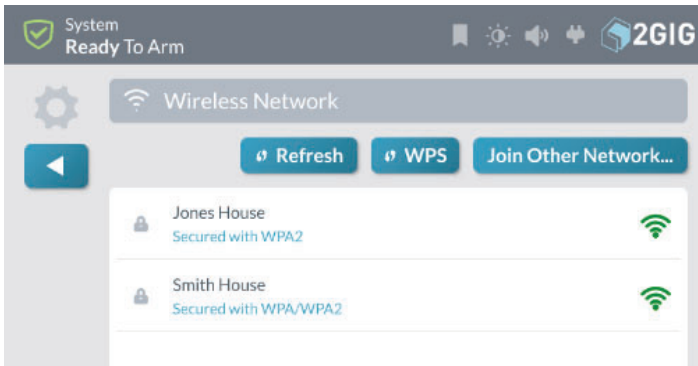

3. Locate and press **WPS** on router.

GC3 Panel will securely connect with the router.

Join Other Network

Tapping **Join Other Network** allows you to join a network not shown in the list.

1. Tap **Join Other Network**.

Join Other Network

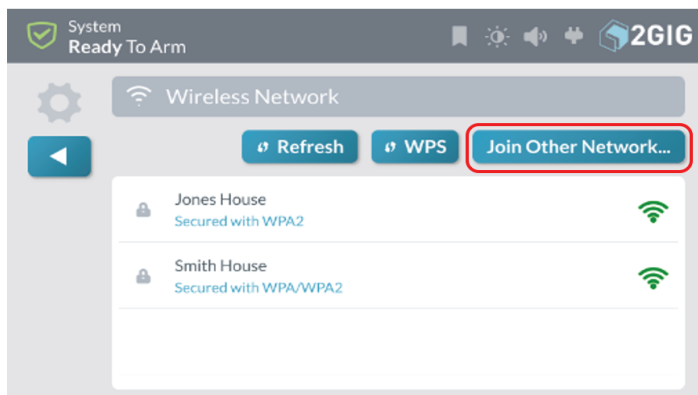

2. Enter network SSID.
3. Select authentication type used by the network.
4. Enter password.

Forget Network

Forget Network

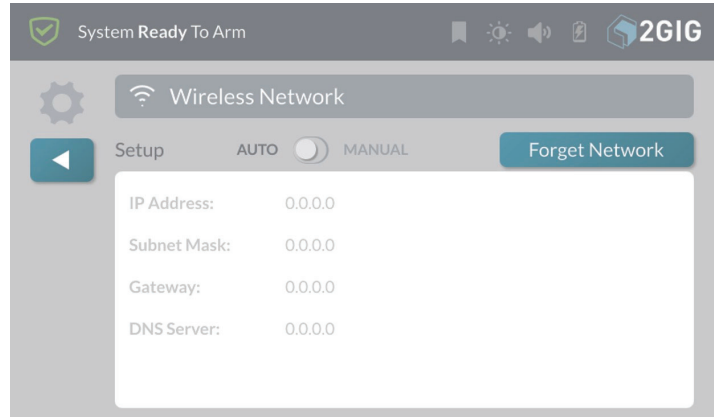

Tapping **Forget Network** disconnects the GC3 Panel from the wireless network and erases the password so that it will not automatically reconnect to the network.

Wired (Ethernet)

Attaching to a Wired Network (Ethernet Network)

Attach to a Wired Network.

1. Navigate to **Installer Toolbox** menu and tap **Network Settings**.



2. Tap **Wired**.

If the DHCP server is available on the network, the GC3 panel will automatically receive an IP address.

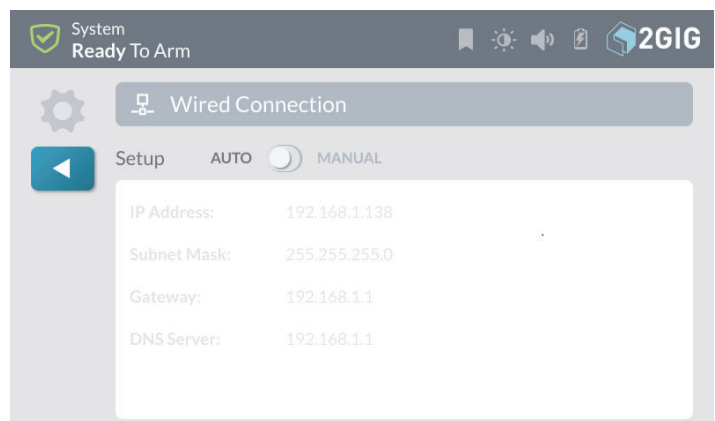

See the section “Setting up a Static IP address” to manually configure a static connection to the network.

3. Tap ▼.

NOTE: Hardwired connection must be active for the Wired tile to be available. Once a hardwired connection is active the Wireless (WiFi) tile will be greyed out.

Access Point

Setup the GC3 Panel Access Point

1. Navigate to the **Installer Toolbox** menu and tap **Network Settings**.
2. Tap **Access Point**

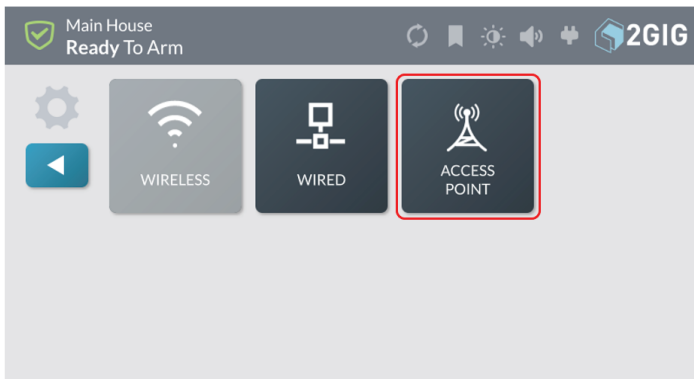

3. Enable Access Point

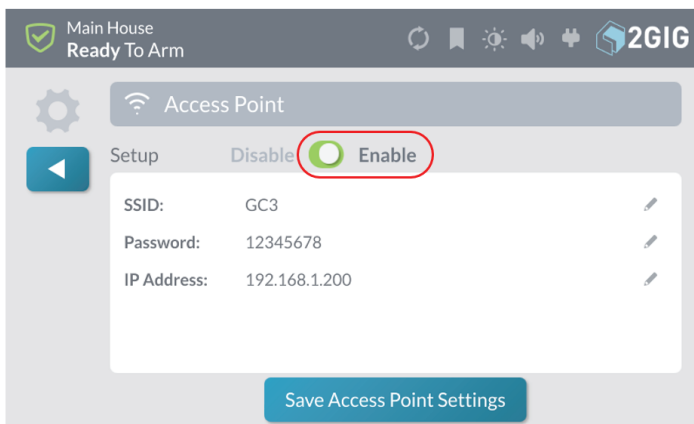

- » **Optional:** Press **Edit** icon next to default SSID, enter new SSID name
 - » **Optional:** Press **Edit** icon next to **Password**, enter new password
 - » **Optional:** Press **Edit** icon next to **IP address**, the last two octets of the Access Point can be changed to customize setup.
4. After any edits have been made, press **Save Access Point Settings** to save any configuration settings.

Note: Make a note of SSID and Password for use in WiFi setup of SP1 and SP2 keypads.

5. Tap ▼.

Setting Up a Static IP Address

By default the the GC3 Panel will connect using DHCP to get the IP Address assignment. If you want to set a Static IP Address, follow these steps.

1. Tap **Manual** and select the **Edit** icon for **IP Address**.

Auto/Manual

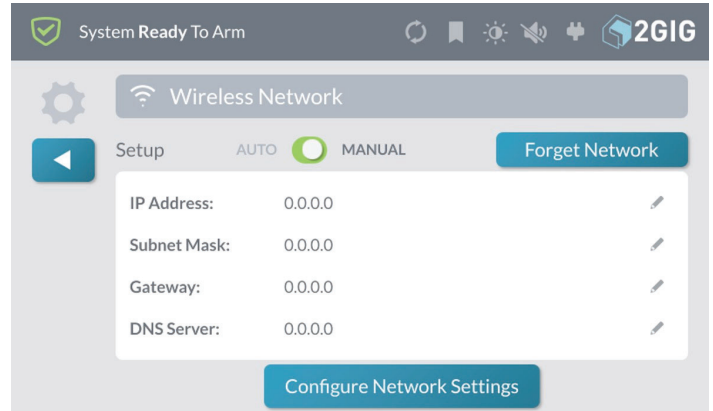

2. Enter the desired IP Address.

IP Address



3. Select the edit icon for **SubNet Mask** and enter the desired **SubNet Mask Address**.

Subnet Mask



- Select the **Edit** icon for **Gateway** and enter the desired **Gateway Address**.

Gateway Address

- Select the **Edit** icon for **DNS Server** and enter the desired **DNS Server Address**.

- Tap **Configure Network Settings**.

Configure Network Settings

Network Test

Testing the Broadband network connection

- Navigate to the **Installer Toolbox** menu and tap **Network Test**.

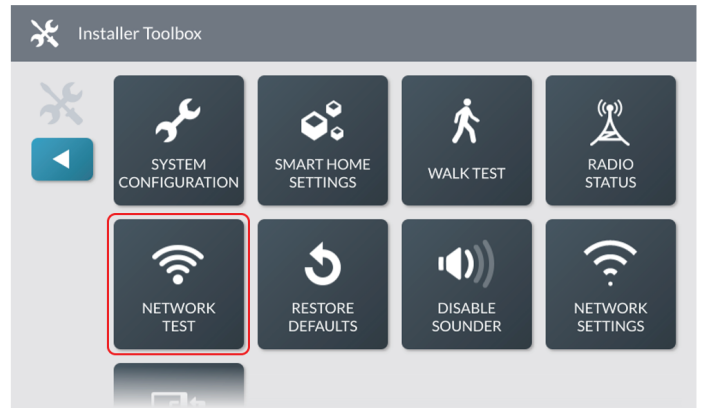

- Tap **Start**.
- The Network test will run:

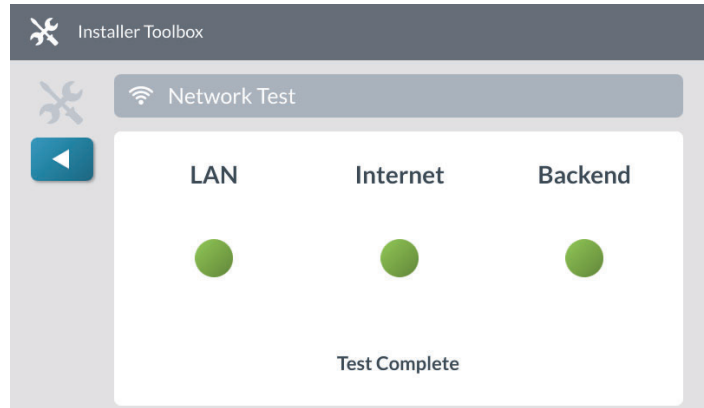

- » If successful green dots will appear under each test: LAN, Internet, and Backend.
- » If a failure is detected a red dot will appear under the test.
 - » **LAN** – Connection to Local Network
 - » **Internet** – Connection to Internet
 - » **Backend** – Connection to Alarm.com

NOTE: Correct any network issues to resolve broadband connectivity

- Tap to return to Installer Toolbox

Pairing with a System

This feature allows the panel to pair with approved third-party systems.

1. Navigate to the **Installer Toolbox** and tap **System Pairing**.

Tap System - Pairing Mode

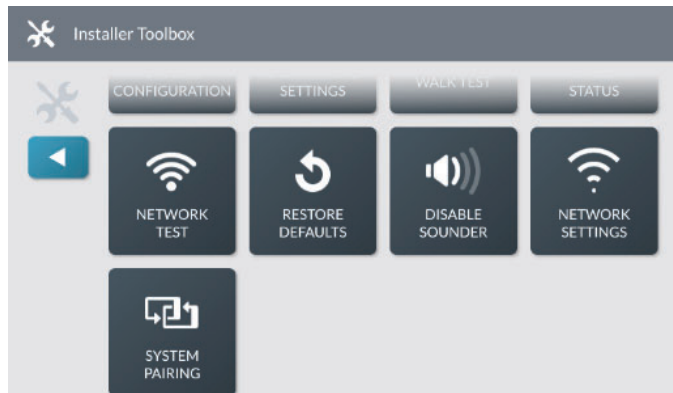

2. Press the **+** button to start the pairing process.

System Pairing - Enter Key



The system will listen for the pairing request from the third party system.

Programming Sensors and Peripherals

Navigate to the System Configuration Menu

The System Configuration menu provides installers with access to programming features for wireless zones, wired zones, keyfobs, and keypads. It also provides installers with access to panel programming options.

To navigate to the **System Configuration** menu:

1. Navigate to the **Installer Toolbox**. See “Navigate to the Installer Toolbox.”

2. At the **Installer Toolbox** menu, tap **System Configuration**.

Navigate to the System Configuration Menu

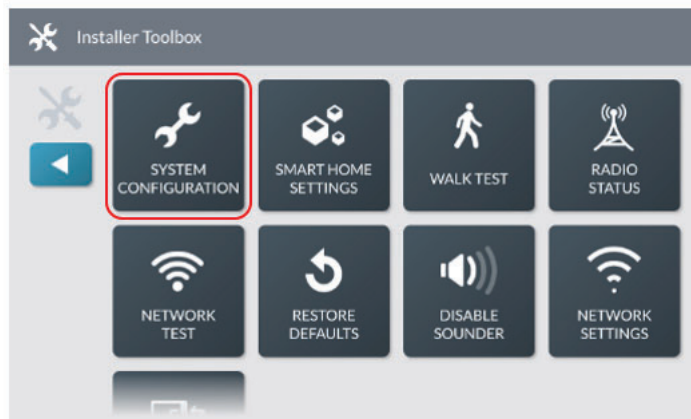

Program a Wireless Zone

The GC3 Panel lets you program a maximum of 100 wireless zones. To begin zone programming, navigate to the **Installer Toolbox**. See “Navigate to the Installer Toolbox” above. Then, tap **System Configuration** > **Wireless Zones**.

NOTES:

When programming eSensors (Wireless & Keyfobs) the equipment code must match the sensor being installed. See page 68 for eSensor Equipment Codes.

eSeries sensors are only compatible with the GC3e panel.

Wireless Zones Menu

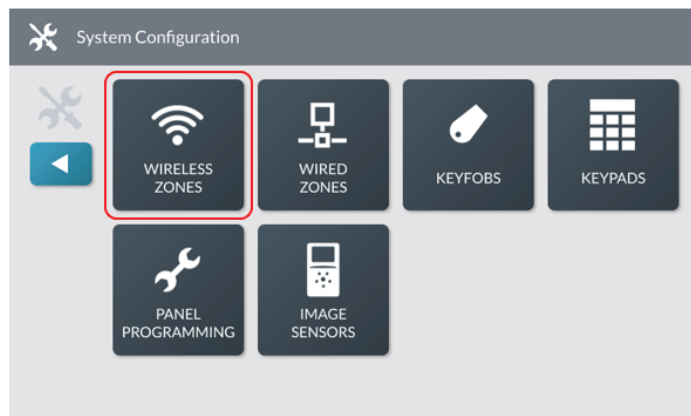

This reveals the **Wireless Zones** screen shown below.

Step 1: Select a Wireless Zone

First, select the wireless zone to edit.

1. On the left side of the **Wireless Zones** screen, swipe up or down to move through the list of zones.
2. Tap one of the available zones to highlight it.

Note: A zone is available for programming when it appears in gray text. A zone that has already been programmed appears in black text.

3. Tap **Edit Zone**.

Wireless Zones Screen

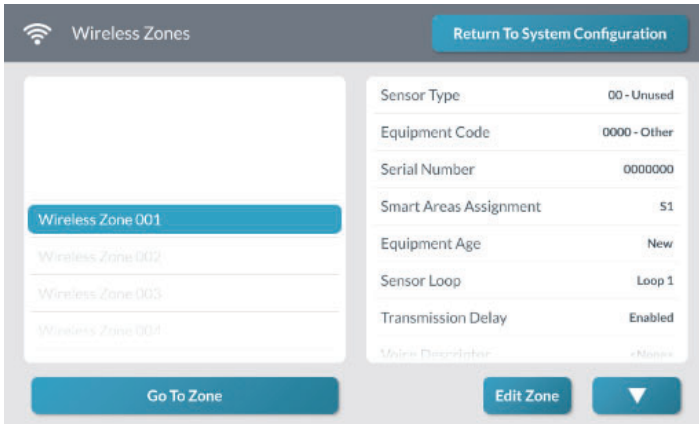

This reveals the **Wireless Zones <###>** screen.

NOTE: S1 is the primary Smart Area (partition) and default.

Step 2: Select a Sensor Type

Next, select the appropriate sensor type for the sensor or peripheral being programmed.

1. At the **Wireless Zone <###>** screen, highlight **Sensor Type**.
2. Tap to expand the list.
3. Tap to select the appropriate sensor type from the list.

For example, if you are programming a *Thin Door/Window Contact for a Front Door*, you might select *01-Exit/Entry* as the sensor type.

Wireless Zone <###> Screen—Sensor Type

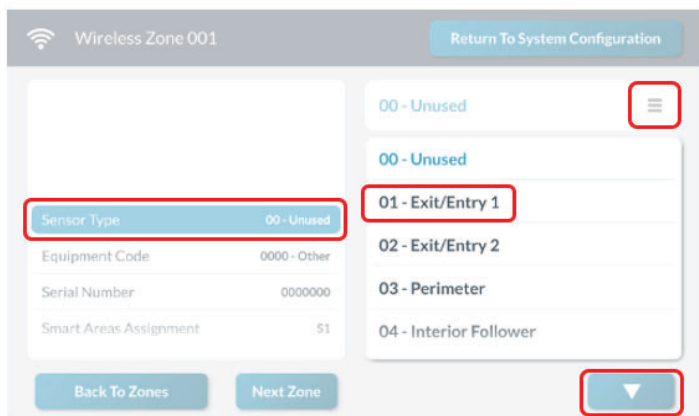

Tip: You can alternatively use the touchscreen keypad to enter the two-digit code to select the **Sensor Type**.

4. Tap .

Step 3: Select the Sensor Equipment Type

Note: If you selected *04-Interior Follower*, *06-24-Hour Silent Alarm*, *07- 24-Hour Audible Alarm*, *08-24-Hour Auxiliary Alarm*, *10-Interior with Delay*, or *23-No Response Type* in “Step 2: Select a Sensor Type” above, you must also select the **Sensor Equipment Type**. If you selected a different **Sensor Type**, skip this step and continue with “Step 4: Select the Equipment Code” below.

1. At the Wireless Zone <###> screen, highlight Sensor Equipment Type.
2. Under Sensor Equipment Type, choose Contact or Emergency or Motion. Available options vary depending on the selected Sensor Type.
3. Tap .

Step 4: Select the Equipment Code

Next, select the four-digit equipment code. For a list of codes, see “Equipment Code.”

1. At the **Wireless Zone <###>** screen, highlight **Equipment Code**.
2. Tap to expand the list.
3. Tap to select the desired equipment code from list.

Wireless Zone Screen—Equipment Code

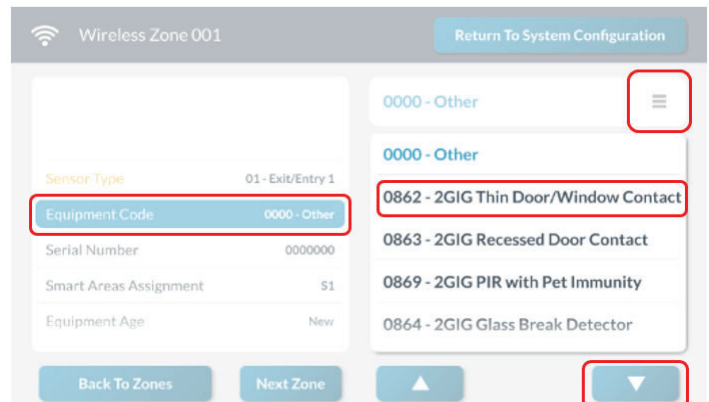

Tip: You can alternatively use the touchscreen keypad to enter the four-digit **Equipment Code**. See “Equipment Code.”

4. Tap .

Step 5: Enter the Serial Number (TX ID)

Next, enter the 7-digit TX ID (this is product’s serial number) for the sensor or peripheral. This is typically affixed to the product and/or its packaging. To enter the number, choose one of these options:

- » **Touchscreen Keypad Entry:** Use the touchscreen keypad to type the TX ID into the system.
OR
- » **Learning Mode Entry:** Place the GC3 Panel into Learning Mode and then trigger the sensor twice to transmit the TX ID from the sensor to the GC3 Panel.

1. At the **Wireless Zone <###>** screen, highlight **Serial Number**.
2. Place the GC3 Panel into Learning Mode by tapping **Learn**.

Wireless Zone Screen—Serial Number Keypad

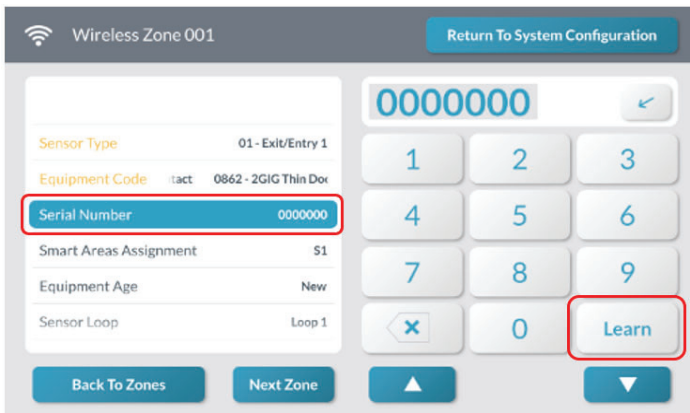

The panel listens for the 7-digit TX ID transmission from the sensor or peripheral.

Wireless Zone Screen—Learning Serial Number

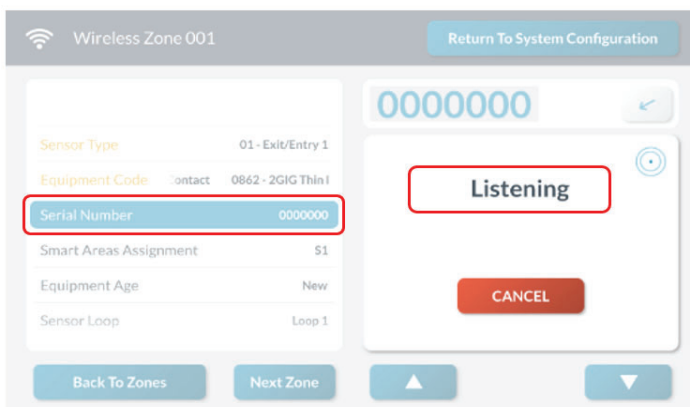

Tip: Instead of placing the GC3 Panel into Learning Mode, you can alternatively use the touchscreen's keypad to manually enter the 7-digit TX ID. Or, if you have previously programmed the wireless zone, you can tap the ✓ button to the right of the entry display field to automatically paste the last entered serial number (TX ID).

3. Trigger the sensor or peripheral. To learn how, see the *Installation Instructions* that came with the product. When the panel receives the sensor's 7-digit TX ID, the **Sensor Received** message appears.
4. Verify that the serial number on the touchscreen matches the 7-digit TX ID on the sensor or peripheral. Then tap **Accept**.
5. Tap ▼.

Step 6: Smart Areas Assignment

Select a Smart Area Assignment.

1. At the **Wireless Zone<###>** screen, highlight **Smart Areas Assignment**.
2. Under **Smart Areas Assignment**, choose a Smart Area (Partition) for the zone.
3. Tap ▼.

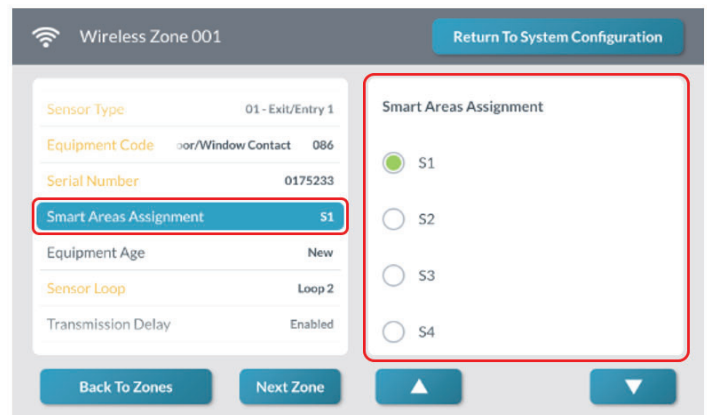

Step 7: Choose the Equipment Age

Next, choose the equipment age.

1. At the **Wireless Zone <###>** screen, highlight **Equipment Age**.
2. Under **Equipment Age**, choose **New** or **Existing**.
3. Tap ▼.

Wireless Zone Screen—Equipment Age

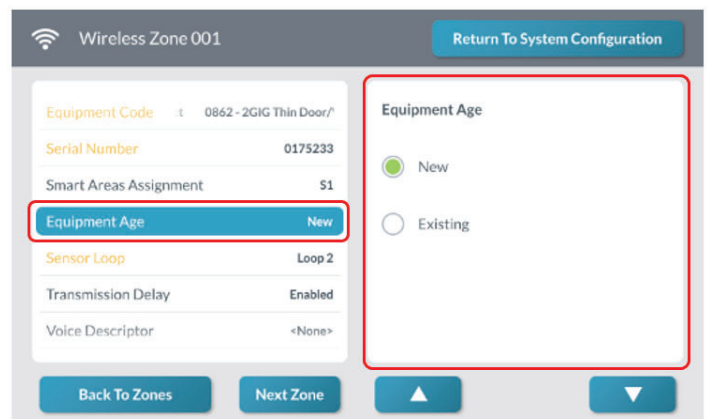

Step 8: Choose the Sensor Loop

A sensor loop is a communication channel that informs the system how to respond when events are triggered. Most 2GIG sensors and peripherals are designed to use **Loop 1** as the default setting. However, some sensors and peripherals have additional features and programming options that require a sensor loop. For example, when programming the Wireless Smoke/Heat/Freeze Alarm, you can program it for smoke detection using **Loop 1**, for heat detection using **Loop 2**, and/or for freeze detection using **Loop 3**. Always check the Installation Instructions that came with the sensor or peripheral or consult with your dealer.

Note: When programming wireless sensors and peripherals, each loop programmed for a wireless sensor is treated as its own zone by the GC3 Panel.

Note: If the serial number (TX ID) for the sensor was added using Learning Mode, the sensor loop will typically be automatically selected for you. However, you must verify that the loop number is correct.

Next, choose the sensor loop:

1. At the **Wireless Zone <###>** screen, highlight **Sensor Loop**.
2. Choose **Loop 1**, **Loop 2**, or **Loop 3**.

Note: To determine the appropriate loop number, see the *Installation Instructions* included with the sensor or peripheral. If the serial number was entered using the Learning Mode in Step 5, the loop will automatically be added.

3. Tap ▼.

Wireless Zone Screen—Sensor Loop

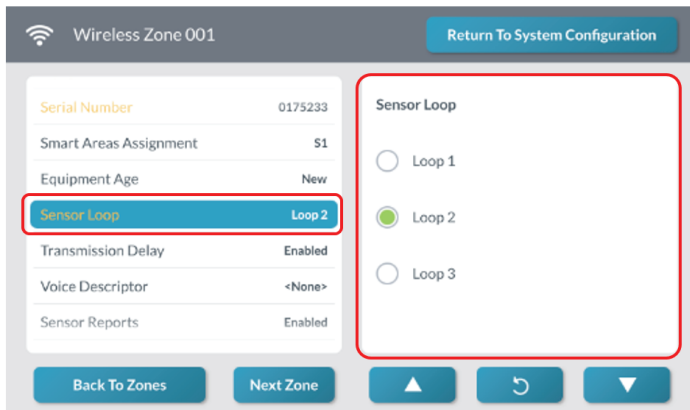

Step 9: Enable or Disable the Transmission Delay

Next, turn the Transmission Delay ON or OFF. When enabled, the feature is ON and the system uses the dialer delay. The transmission delay specifies the amount of time the system waits for it to initiate the digital transmission when an alarm condition is triggered (see “Q39: Alarm abort window transmission delay.” When set to OFF, the dialer delay is not used.

Note: This setting does not apply to CO or smoke alarms.

1. At the **Wireless Zone <###>** screen, highlight **Dialer Delay**.

2. Under **Dialer Delay**, choose **Enabled** or **Disabled**.
3. Tap ▼.

Wireless Zone Screen—Transmission Delay

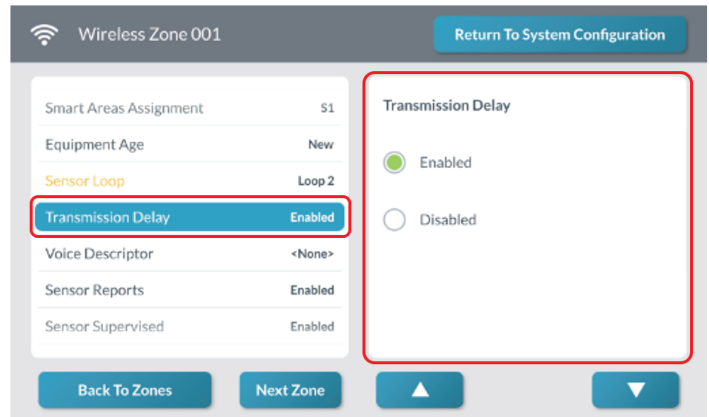

Step 10: Select a Voice Descriptor

Next, create a voice descriptor for the sensor or peripheral using the words in the system’s vocabulary. See “Voice Descriptor.”

1. At the **Wireless Zone <###>** screen, highlight **Voice Descriptor**.
2. Tap **Edit Voice Descriptor** to reveal the touchscreen keypad.

Wireless Zone Screen—New Voice Descriptor

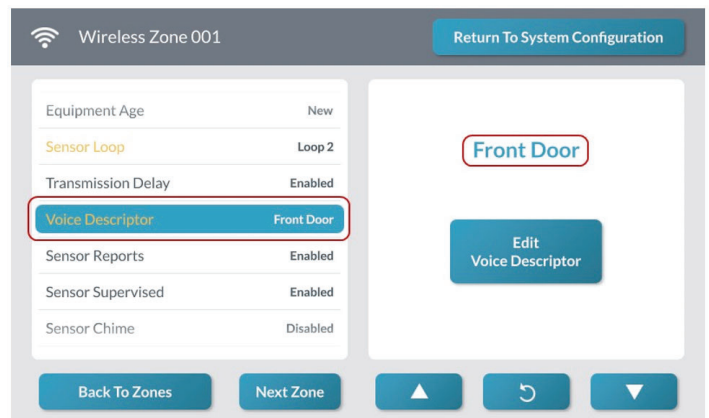

Step 11: Enable or Disable Sensor Reports

Next, turn the sensor reports feature ON or OFF. When enabled, the feature is ON and the system sends a report to the Central Station when the sensor or peripheral triggers an alarm. When disabled, the feature is OFF and reports are not sent to the Central Station.

Note: If this report feature is turned OFF< the sensor can still be used to trigger an alarm.

1. At the **Wireless Zone <###>** screen, highlight **Sensor Reports**.

2. Under **Sensor Reports**, choose **Enabled** or **Disabled**.

Wireless Zone <###>—Sensor Reports

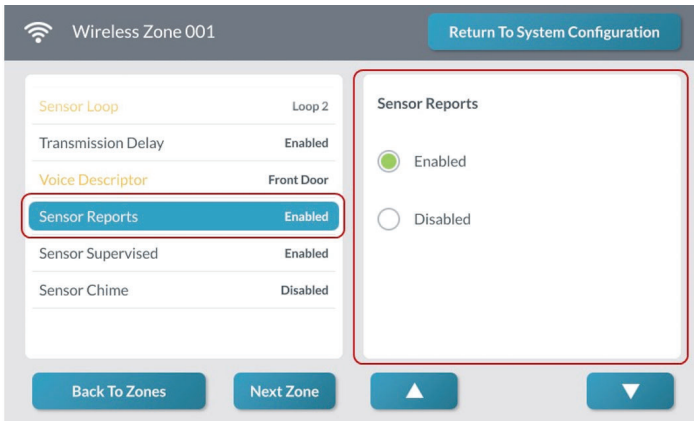

3. Tap ▼.

Step 12: Enable or Disable Sensor Supervision

Next, turn the **Sensor Supervised** option ON or OFF. When enabled, the feature is ON and the GC3 Panel checks for regular, wireless transmissions from the sensor or peripheral. If the GC3 Panel doesn't receive a transmission from the sensor after a set amount of time, the system issues a loss of supervision trouble report. When disabled, the feature is OFF.

Note: Because portable sensors (for example, the Panic Button Remote) are frequently moved out of the system's range when users leave the premises, always disable the **Sensor Supervised** for panic buttons. A sensor will still report to the Central Station with supervision disabled.

1. At the **Wireless Zone <###>** screen, highlight **Sensor Supervised**.
2. Under **Sensor Supervised**, choose **Enabled** or **Disabled**.
3. Tap ▼.

Wireless Zone <###>—Sensor Supervised

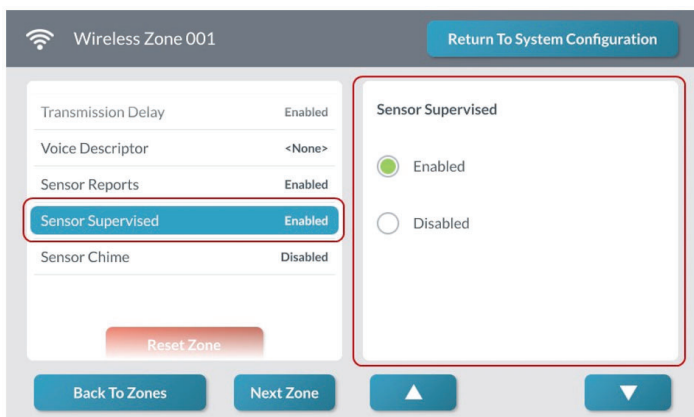

Step 13: Choose a Chime

Next, select the desired chime for the sensor or peripheral.

1. At the **Wireless Zone <###>** screen, highlight **Sensor Chime**.
2. Choose the desired chime from the **Sensor Chime** list. The default setting is **Disabled**.

Wireless Zone <###>—Sensor Chime

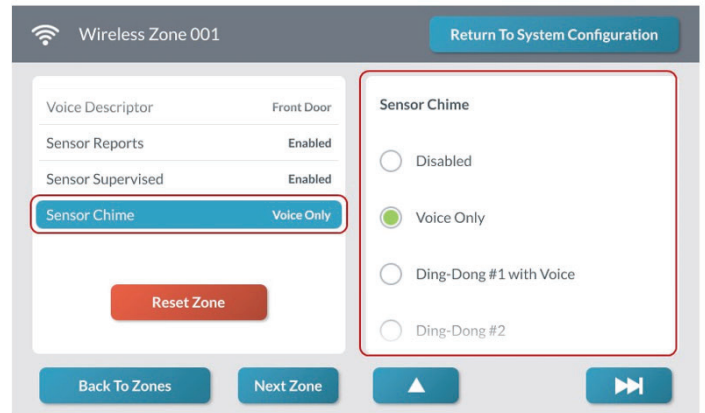

Next Steps

You have finished programming a wireless zone. You can now choose one of these options:

- » To program the next wireless zone, tap **Next Zone** and repeat the programming steps for another sensor. The system keeps track of all your programming changes and prompts you to permanently save all your changes as a group when you exit the **System Configuration** menu.
- » To program the next wireless zone, tap **uu|**. This button becomes visible and available only when programming the last setting for a zone.
- » To erase all of the settings you just programmed for the zone, tap **Reset Zone**.
- » To permanently save the settings you just programmed, tap **Return to System Configuration**. Then tap **Return**. At the **Confirm Changes** screen, tap **Save**.

Program a Wired Zone

The GC3 Panel lets you program a maximum of two (2) wired zones. To begin zone programming, navigate to the **Installer Toolbox**. See “Navigate to the Installer Toolbox.” Then, tap **System Configuration > Wired Zones**.

System Configuration > Wired Zones

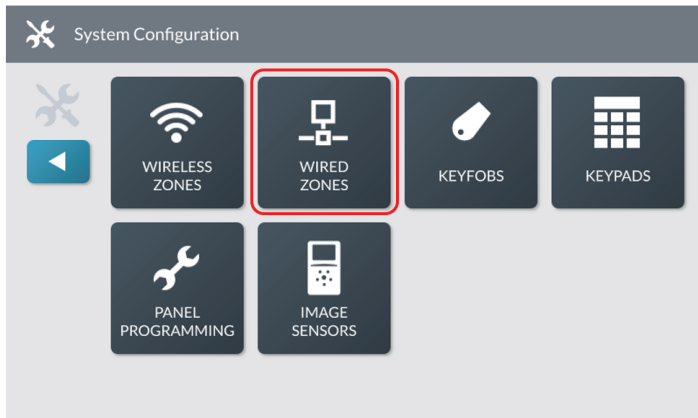

This reveals the **Wired Zones** screen shown in step that follows.

Step 1: Select a Wired Zone

First, select the wired zone to edit:

1. On the left side of the **Wired Zones** screen, review the list of zones.
2. Tap one of the available zones to highlight it.

Note: A zone is available for programming when it appears in gray text. A zone that has already been programmed appears in black text.

3. Tap Edit Zone.

Wired Zones—Edit Zone Button

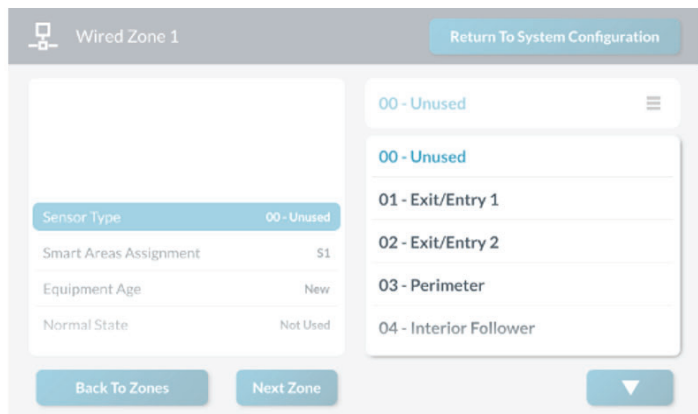

Step 2: Select a Sensor Type

Next, select the appropriate sensor type for the sensor or peripheral being programmed.

1. At the **Wired Zone <###>** screen, highlight **Sensor Type**.
2. Tap  to expand the list.

3. Tap to select the appropriate sensor type from the list.

Wired Zone <###>—Sensor Type

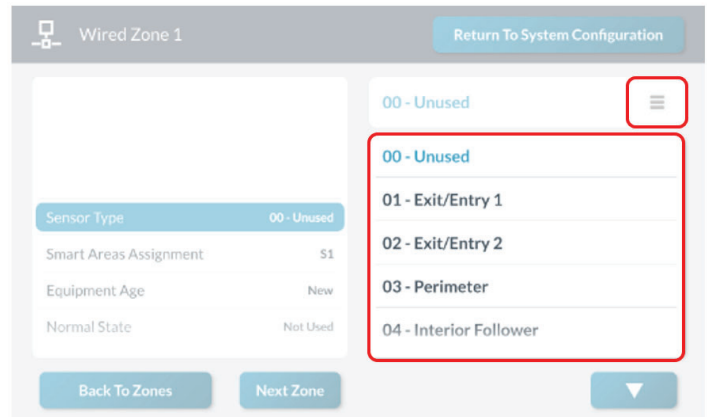

If you selected *04-Interior Follower*, *06-24-Hour Silent Alarm*, *07- 24-Hour Audible Alarm*, *08-24-Hour Auxiliary Alarm*, *10-Interior with Delay*, or *23-No Response Type* in “Step 1: Select a Wired Zone” above, you must also select the **Sensor Equipment Type**. If you selected a different Sensor Type, skip this step and continue with “Step 3: Choose the Equipment Age” below.

Tip: You can alternatively use the touchscreen keypad to enter the two-digit code to select the **Sensor Type**.

4. Tap .

Step 3: Select a Smart Area Assignment

Select the Smart Area Assignment.

1. At the **Wired Zone<###>** screen, highlight **Smart Areas Assignment**.
2. Under **Smart Areas Assignment**, choose the Smart Area (Partition) for the zone.
3. Tap .

Wired Zone <###>—Choose Smart Area

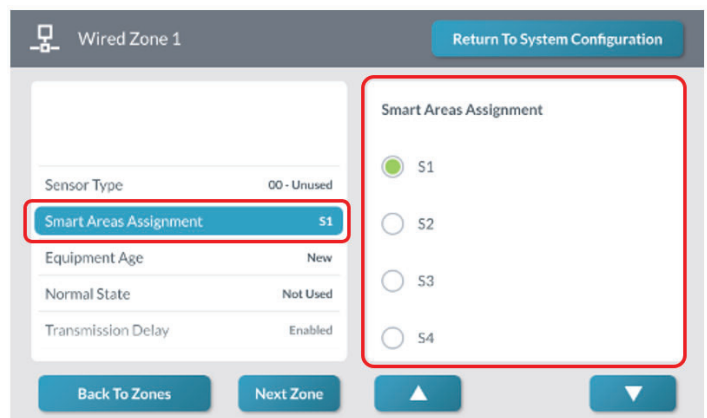

Step 4: Choose the Equipment Age

Next, choose the equipment age:

1. At the **Wired Zone <###>** screen, highlight **Equipment Age**.
2. Under **Equipment Age**, choose **New** or **Existing**.

Figure 23 Wired Zone <###>—Equipment Age

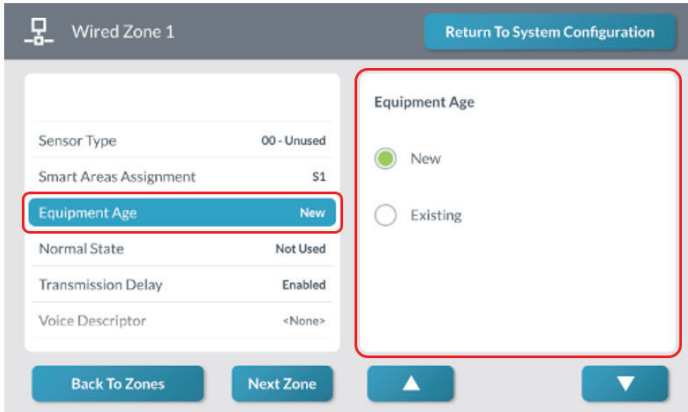

3. Tap ▼.

Step 5: Choose the Normal State

Next, choose the normal state of the circuit for the switching component for the wired sensor or peripheral.

1. At the **Wired Zone <###>** screen, highlight **Normal State**.
2. Under **Normal State**, choose one of these options:
 - » **Not Used:** Turns the switching component OFF and disables the use of the sensor or peripheral for the zone. This is the default setting.
 - » **Normally Closed (NC):** Sends an alert signal to the security system when the sensor's circuit is no longer in the NC state. For example, if the security system was armed and a wired door/window contact programmed as NC goes into the NO state, the change from NC to NO would trigger an alarm.
 - » **Normally Open (NO):** Sends an alert signal to the security system when the sensor's circuit is no longer in the NO state. For example, if the security system was armed and a wired door/window contact programmed as NO goes into the NC state, the change from NO to NC would trigger an alarm.
 - » **End-of-Line Resistor (EOL):** Choose this option when an end-of-line (EOL) resistor is present.

Note: An EOL resistor must be installed at the sensor, not at the panel.

Wired Zone <###>—Normal State

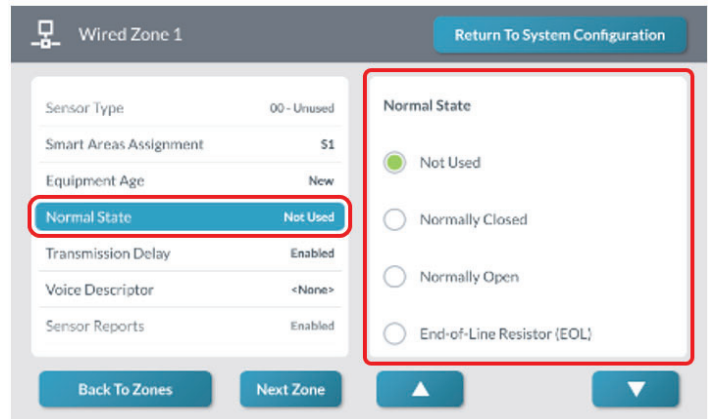

Step 6: Enable or Disable the Transmission Delay

Next, turn the Transmission Delay ON or OFF.

1. At the **Wired Zone <###>** screen, highlight **Transmission Delay**.
2. Under **Transmission Delay**, choose **Enabled** or **Disabled**.

Wired Zone <###>—Transmission Delay

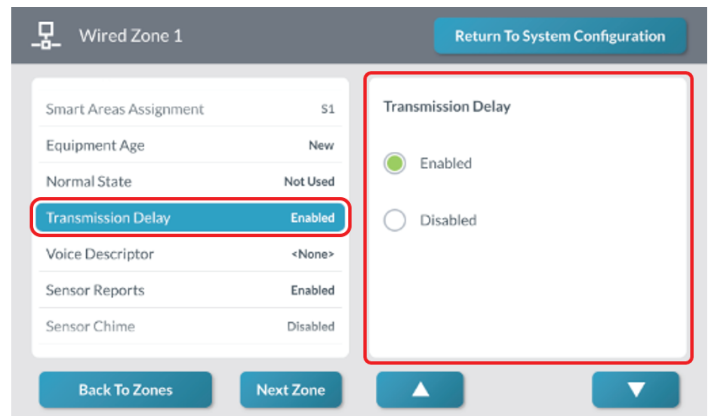

3. Then tap ▼.

Step 7: Select a Voice Descriptor

Next, create a voice descriptor for the sensor or peripheral using the words in the system's vocabulary. See "Voice Descriptor."

1. At the **Wired Zone <###>** screen, highlight **Voice Descriptor**.

2. Tap **Edit Voice Descriptor** to reveal the touchscreen keypad.

Wired Zone <###>—Edit Voice Descriptor

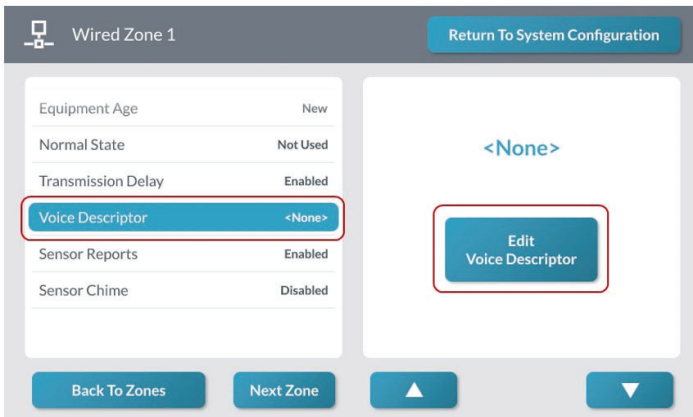

3. At the touchscreen keypad, enter the first few letters of the desired vocabulary word.
4. Tap the matching vocabulary word above the touchscreen keypad to select it.

Voice Descriptor—Touchscreen Keypad Entry

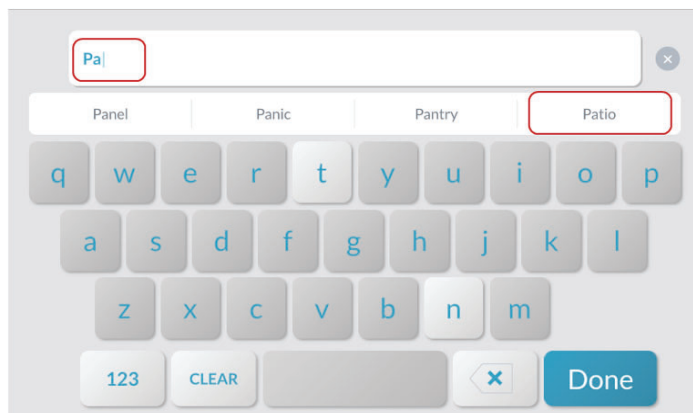

Note: You can scroll through the list of vocabulary words by swiping to the right or the left.

5. Repeat the steps above to enter the desired phrase. Enter up to six words to create a voice descriptor.
6. Tap **Done**.

Voice Descriptor—Touchscreen Keypad Entry

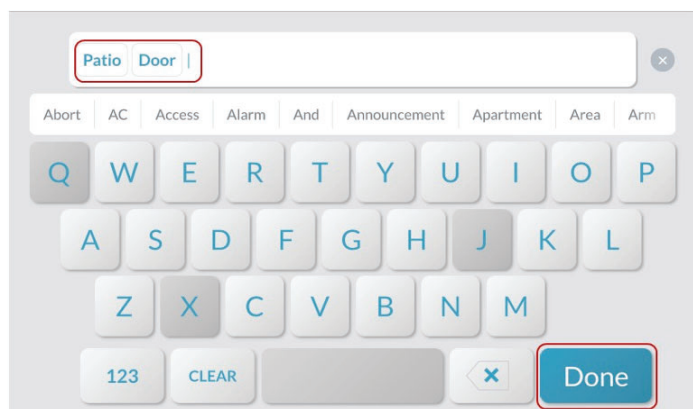

7. Review the voice descriptor.

Review Voice Descriptor

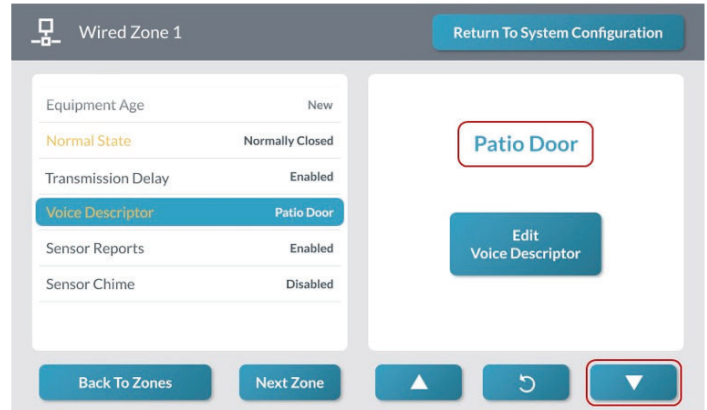

8. Tap ▼.

Step 8: Enable or Disable Sensor Reports

Next, turn the sensor reports feature ON or OFF. When enabled, the feature is ON and the system sends a report to the Central Station when the sensor or peripheral is triggered. When disabled, the feature is OFF and reports are not sent to the Central Station.

1. At the **Wired Zone <###>** screen, highlight **Sensor Reports**.
2. Under **Sensor Reports**, choose **Enabled** or **Disabled**.

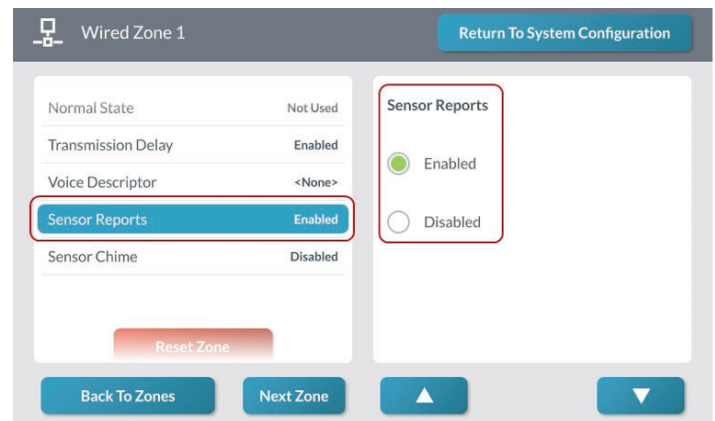

3. Tap ▼.

Step 9: Choose a Chime

Next, select the desired chime for the sensor or peripheral.

1. At the **Wired Zone <###>** screen, highlight **Sensor Chime**.

- Choose the desired chime from the **Sensor Chime** list. The default setting is **Disabled**.

Wired Zone <###>—Sensor Chime

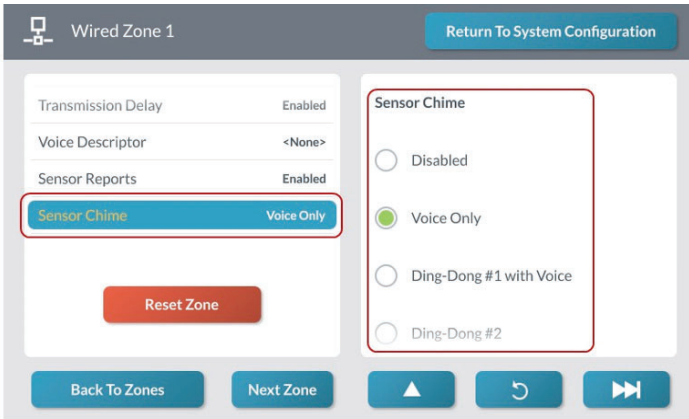

Next Steps

You have finished programming a wired zone. You can now choose one of these options:

- » To program the next wired zone, tap **Next Zone** and repeat the programming steps for another sensor. The system keeps track of all your programming changes and prompts you to permanently save all your changes as a group when you exit the **System Configuration** menu.
- » To program the next wired zone, tap **uu|**. This button becomes visible and available only when programming the last setting for a zone.
- » To erase all of the settings you just programmed for the zone, tap **Reset Zone**.
- » To permanently save the settings you just programmed, tap **Return to System Configuration**. Then tap **Save**. At the **Confirm Changes** screen, tap **Save**.

Program a Keyfob

The GC3 Panel lets installers program up to 32 portable keyfobs per system. To begin zone programming, navigate to the **Installer Toolbox**. See “Navigate to the Installer Toolbox.” Then tap **System Configuration > Keyfobs**.

NOTES:

When programming eSensors (Wireless & Keyfobs) the equipment code must match the sensor being installed. See page 68 for eSensor Equipment Codes.

eSeries sensors are only compatible with the GC3e panel.

System Configuration Menu

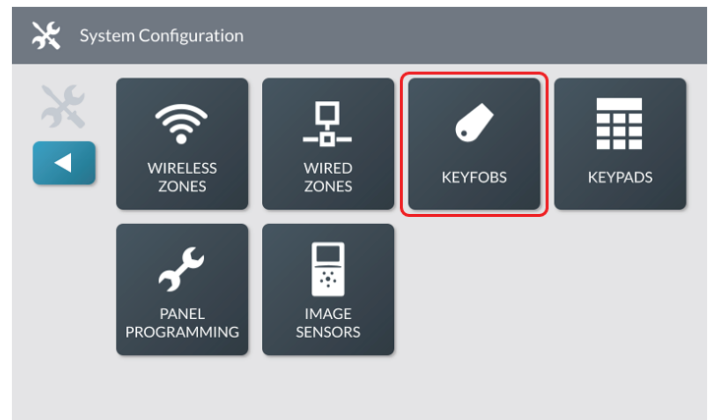

This reveals the **Keyfobs** screen shown in the next step.

Step 1: Select a Keyfob

First, select the keyfob to edit.

- At the Keyfobs screen, swipe up and down to move through the list of keyfobs.
 - Tap to select one of the available keyfobs.
- Note:** A keyfob is available for programming when it appears in gray text. A keyfob that has already been programmed appears in black text.
- Tap **Edit Keyfob**.

Keyfobs Screen—Edit Keyfob

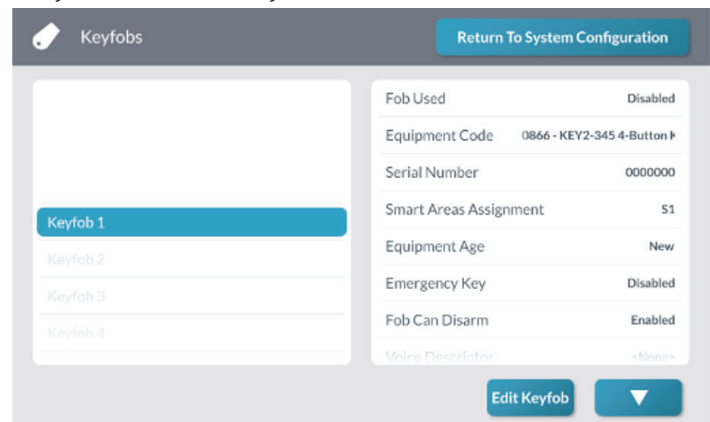

This reveals the Keyfobs screen shown in the next step.

Step 2: Enable or Disable the Fob Used

Next, enable or disable the Fob Used option. When enabled, the keyfob is ON and can be used with the system. When disabled, the keyfob is OFF and cannot be used with the system (this is the default setting).

- At the **Keyfob <###>** screen, highlight **Fob Used**.

2. Under **Fob Used**, choose **Enabled** or **Disabled**.

Keyfobs <###> Screen—Fob Used

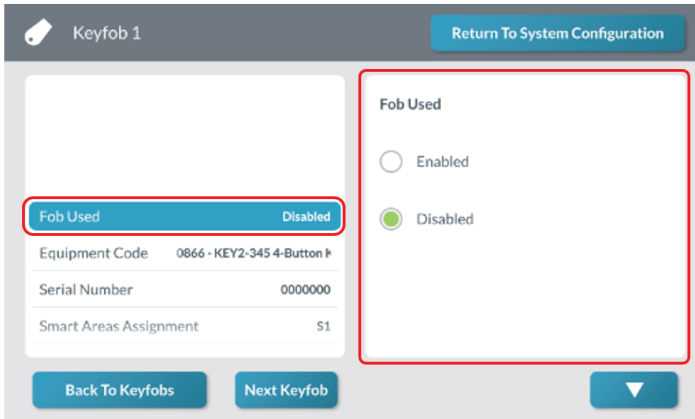

3. Tap ▼.

Step 3: Select Equipment Code

Next, select the equipment code for the keyfob.

1. At the Keyfob <###> screen, highlight Equipment Code.
2. Tap ≡ to expand the list.
3. Tap to select the desired equipment code from the list.

Keyfob <###> Screen—Equipment Code

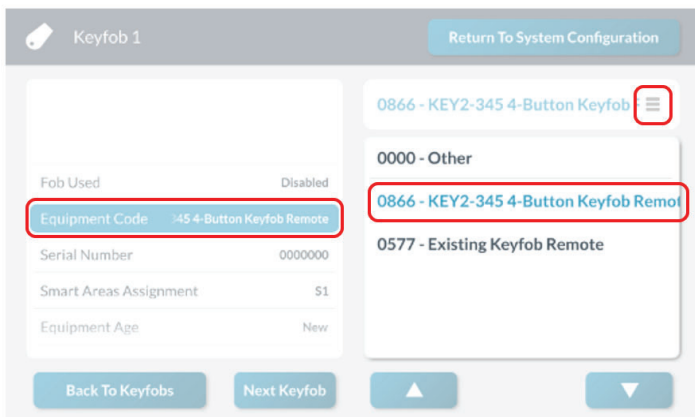

Tip: You can alternatively use the touchscreen keypad to enter the four-digit Equipment Code. See “Equipment Code.”

4. Tap ▼.

Step 4: Enter Serial Number

Next, enter the 7-digit TX ID (this is product’s serial number) for the keyfob. This is typically affixed to the product and/or its packaging. To enter the number, choose one of these options:

» **Touchscreen Keypad Entry:** Use the touchscreen keypad to type the TX ID into the system.

OR

» **Learning Mode Entry:** Place the GC3 Panel into Learning Mode and then trigger the keyfob to transmit the TX ID from the keyfob to the GC3 Panel.

1. At the **Keyfob <###>** screen, highlight **Serial Number**.
2. Place the panel into Learning Mode by tapping **Learn**.

Keyfob <###> Screen—Serial Number

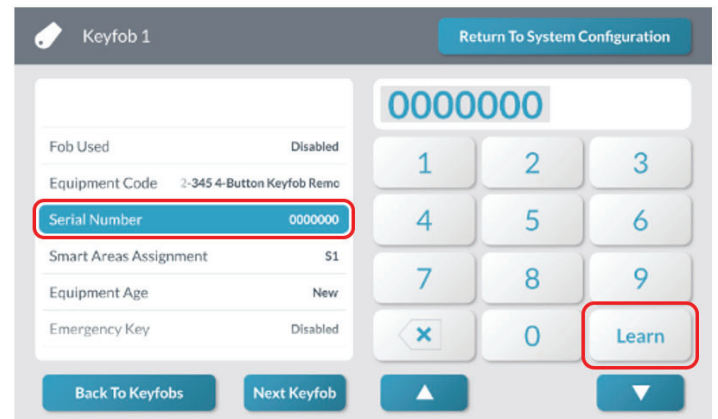

The panel listens for the 7-digit TX-ID transmission from the sensor or peripheral.

Keyfob <###> Screen—Listening for TX ID

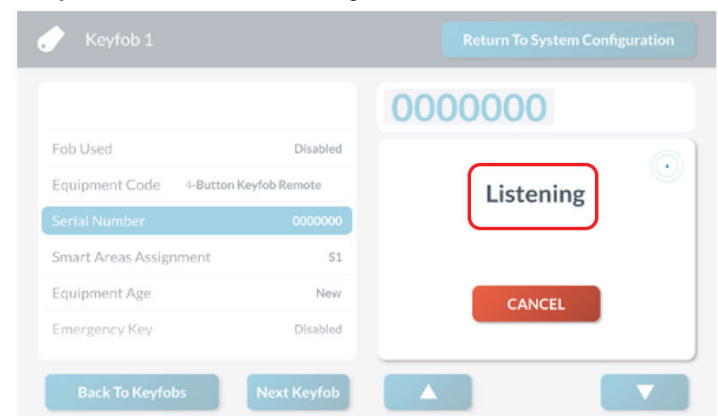

3. Press any button on the keyfob for three (3) to five (5) seconds. When the TX ID is received, the **Sensor Received** message appears.
4. Verify the serial number on the touchscreen matches the keyfob’s 7-digit TX ID. Then tap **Accept**.

Keyfob <###> Screen—Accept Serial Number

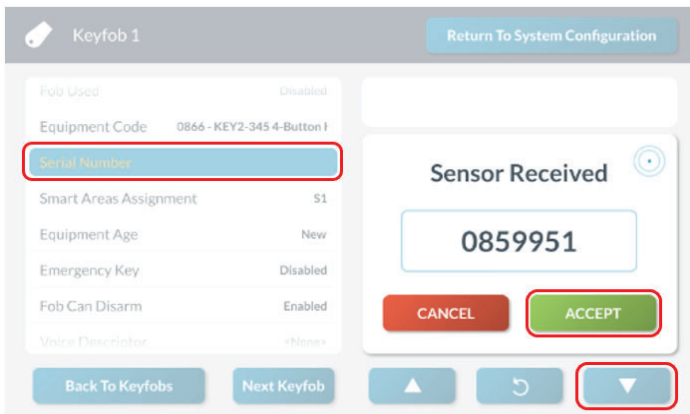

Tip: Instead of placing the GC3 Panel into Learning Mode, you can manually enter the 7-digit TX ID on the keyfob.

5. Tap ▼.

Step 5: Selecting the Smart Area Assignment

Select a Smart Area Assignment.

1. At the **Wireless Zone<###>** screen, highlight **Smart Areas Assignment**.
2. Under **Smart Areas Assignment**, choose a Smart Area (Partition) for the zone.
3. Tap ▼.

Keyfob <###> Screen—Choose Smart Area

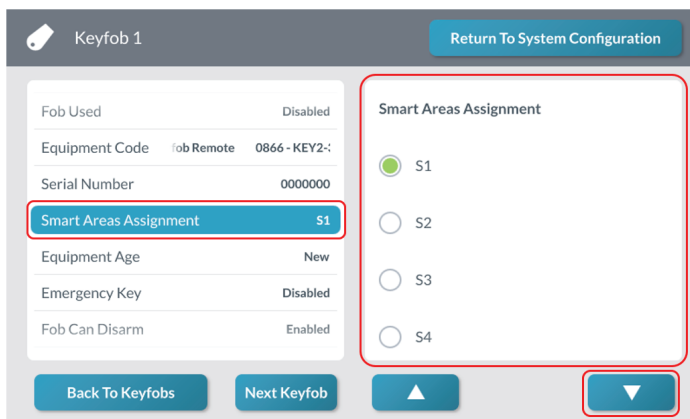

NOTE: If Smart Areas option is enabled (Q69), keyfob can be assigned to a single Smart Area and will arm/disarm and initiate alarms (if programmed) on the assigned Smart Area only.

Step 6: Choose the Equipment Age

Next, choose the equipment age.

1. At the **Keyfob <###>** screen, highlight **Equipment Age**.
2. Under **Equipment Age**, choose **New** or **Existing**.

Keyfob <###> Screen—Equipment Age

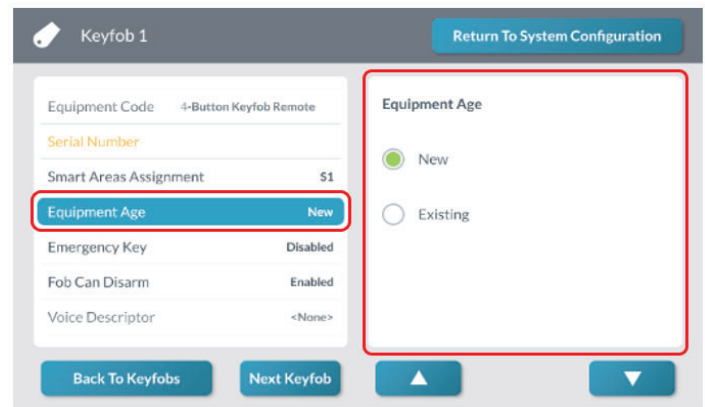

3. Tap ▼.

Step 7: Enable the Emergency Key

Next, choose whether simultaneously pressing the **Arm Away** and **Disarm** buttons on the keyfob triggers an emergency alarm.

1. At the Keyfob <###> screen, highlight Emergency Key.
2. Under Emergency Key, choose one of these options:
 - » **Disabled:** This turns the emergency key function OFF on the keyfob.
 - » **Auxiliary:** This setting triggers a 24-hour auxiliary alarm on the system.
 - » **Audible:** This setting triggers a 24-hour audible alarm on the system.
 - » **Silent Panic:** This setting triggers a 24-hour silent alarm on the system.

Keyfob <###> Screen—Emergency Key

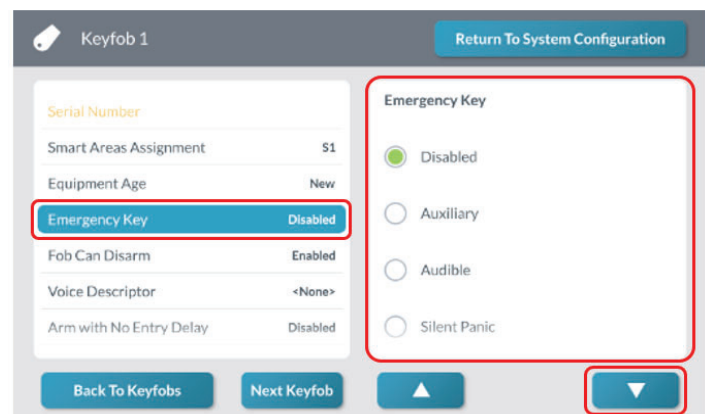

3. Tap ▼.

Step 8: Enable or Disable Fob Can Disarm

Next, choose whether the keyfob can be used to disarm the system. When enabled, the keyfob has the ability to disarm the system. When disabled, the keyfob does not have the ability to disarm the system.

1. At the **Keyfob <###>** screen, highlight **Fob Can Disarm**.
2. Under **Fob Can Disarm**, choose **Enabled** or **Disabled**.

Keyfob <###> Screen—Fob Can Disarm

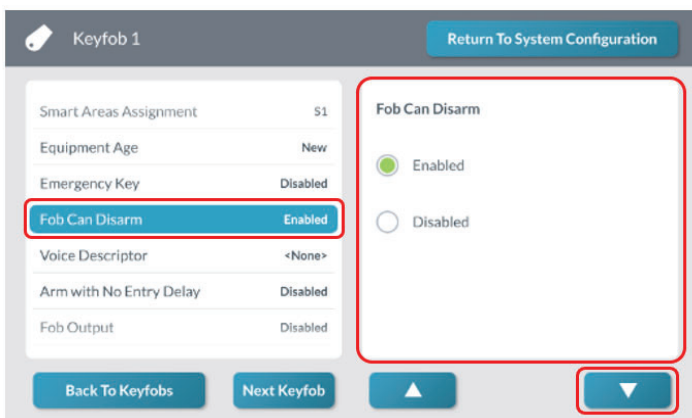

3. Tap ▼.

Step 9: Edit Voice Descriptor

Next, create a voice descriptor for the keyfob using the words in the system's vocabulary. See "Voice Descriptor."

1. At the **Keyfob <###>** screen, highlight **Voice Descriptor**.
2. Tap **Edit Voice Descriptor** to reveal the touchscreen keypad.

Keyfob Programming—Edit Voice Descriptor

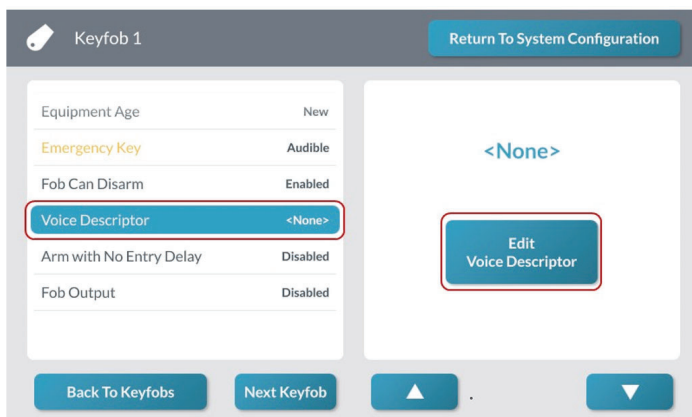

3. At the touchscreen keypad, enter the first few letters of the desired vocabulary word.
4. Tap the matching vocabulary word above the touchscreen keypad to select it.

Keyfob Programming—Word Entry Touchscreen

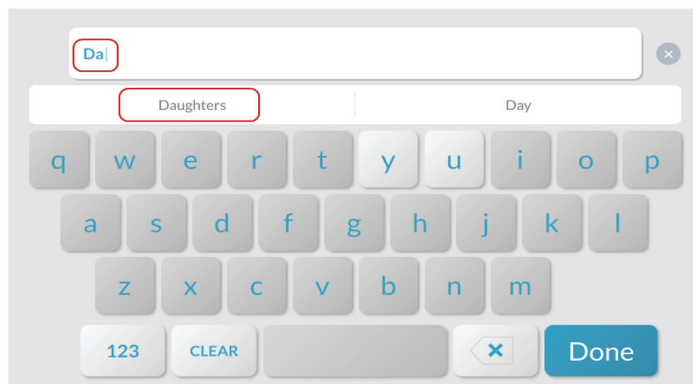

5. Repeat the steps above to enter the desired phrase for the keyfob. Enter up to six words to make a voice descriptor.
6. Tap **Done**.
7. Review the voice descriptor.

Keyfob Programming—New Voice Descriptor

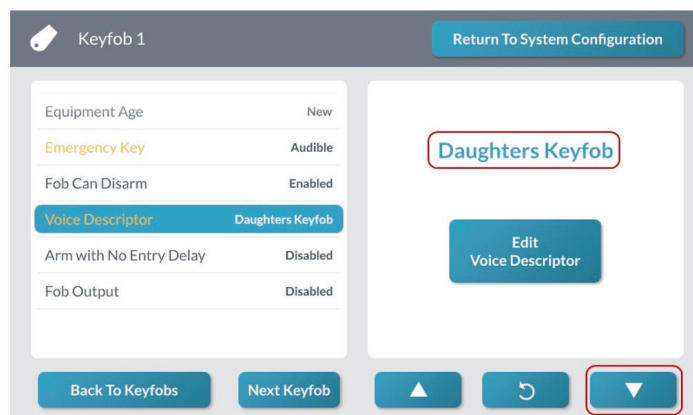

8. Tap ▼.

Step 10: Enable or Disable Arm with No Entry Delay

Next, enable or disable the **Fob Arm with No Delay** option. When enabled, the option is turned ON, the system ignores all Entry Delay timers (see "Q5: Entry delay 1, in seconds (30-240)" and "Q6: Entry delay 2, in seconds (30-240)") when a keyfob is used to arm the system. When disabled, the option is turned OFF and the system uses the Entry Delay timers when a keyfob is used to arm the system.

1. At the **Keyfob <###>** screen, highlight **Arm with No Entry Delay**.

- Under **Arm with No Entry Delay**, choose **Enabled** or **Disabled**.

Keyfob Programming—Arm with No Entry Delay

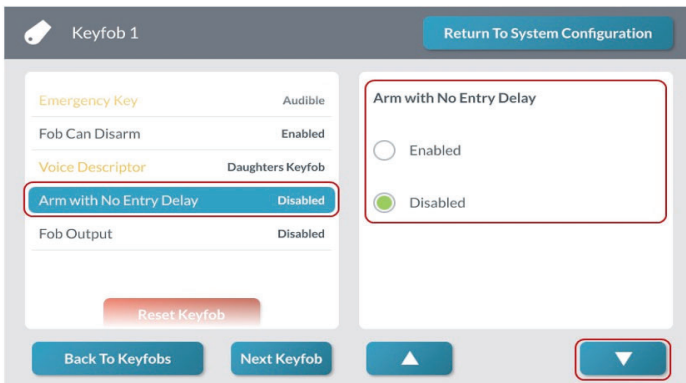

- Tap ▼.

Step 11: Enable or Disable Fob Output

Finally, select whether the auxiliary (*) button on the keyfob can be used to trigger the GC3 Panel's Open Collector #1 output.

- At the **Keyfob <###>** screen, highlight **Fob Output**.
- Under **Fob Output**, choose one of these options:
 - » **Disabled**: This deactivates the option.
 - » **Toggle Output**: Choose this option for toggle output. This lets users press the Auxiliary (*) button on the fob to control the device that is connected to the system's Open Collector Output #1. For example, to use the keyfob to open and close a garage door, you would typically choose Toggle Output.
 - » **Momentary Output**: Choose this option for momentary output. This lets users press the Auxiliary (*) button on the fob to control the device that is connected to the system's Open Collector Output #1. For example, to use the keyfob to turn system-controlled lights ON or OFF, you would typically choose Momentary Output.

Keyfob <###> Screen—Fob Output

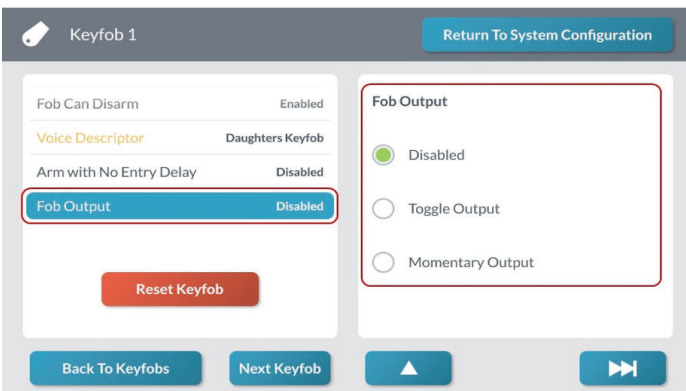

Next Steps

You have finished programming a keyfob. You can now choose one of these options:

- » To program another keyfob, tap **Next Keyfob** and repeat the programming steps for another keyfob. The system keeps track of all your programming changes and prompts you to permanently save all your changes as a group when you exit the **System Configuration** menu.
- » To program the next keyfob, tap uu|. This button becomes visible and available only when programming the last setting for a keyfob.
- » To erase all of the settings you just programmed for the keyfob, tap **Reset Keyfob**.
- » To permanently save the settings you just programmed, tap **Return to System Configuration**. Then tap ◀. At the **Confirm Changes** screen, tap **Save**.

Program a Keypad

The GC3 Panel lets you program a maximum of eight (8) keypads. To begin keypad programming, navigate to the **Installer Toolbox**. See "Navigate to the Installer Toolbox." Then tap **System Configuration > Keypads**.

System Configuration Menu

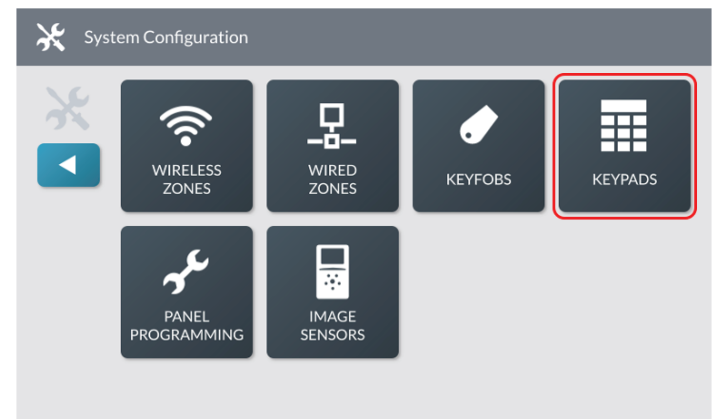

This reveals the **Keypads** screen shown in the step that follows.

Step 1: Select a Keypad

First, select the keypad to edit:

- On the left side of the Keypads screen, swipe up to move through the list of keypads.
- Tap one of the available keypads to select it.

Note: A keypad is available for programming when it appears in gray text. A keypad that has already been programmed appears in black text.

3. Tap **Edit Keypad**.

For example, tap *Keypad 1* to select it.

Keypads Screen—Edit Keypad

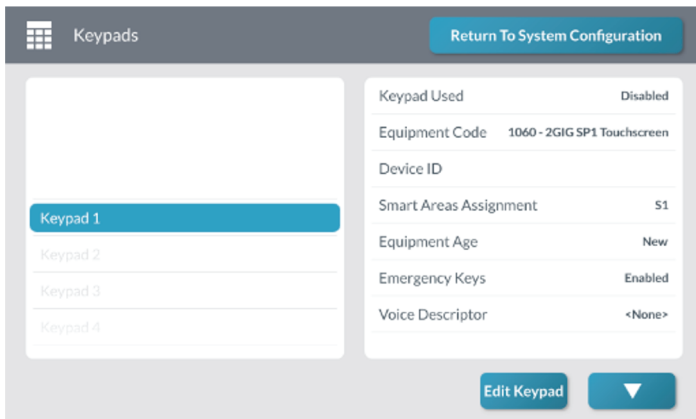

Step 2: Enable or Disable Keypad Used

Next, enable or disable the keypad. When enabled, the keypad can be used with the system. When disabled, the keypad cannot be used with the system.

1. At the **Keypad <###>** screen, highlight **Keypad Used**.
2. Under **Keypad Used**, choose **Enabled** or **Disabled**.

Keypad <###> Screen—Keypad Used

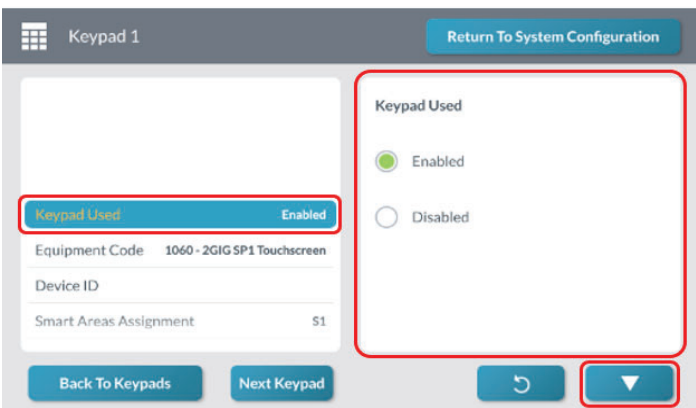

3. Tap ▼.

Step 3: Select Equipment Code

For a complete list of the system's four-digit equipment codes, see "Equipment Code."

1. At the **Keypad <###>** screen, highlight **Equipment Code**.
2. Tap ☰ to expand the list.
3. Tap to select the desired equipment code from the list.

Keypad <###> Screen—Equipment Code

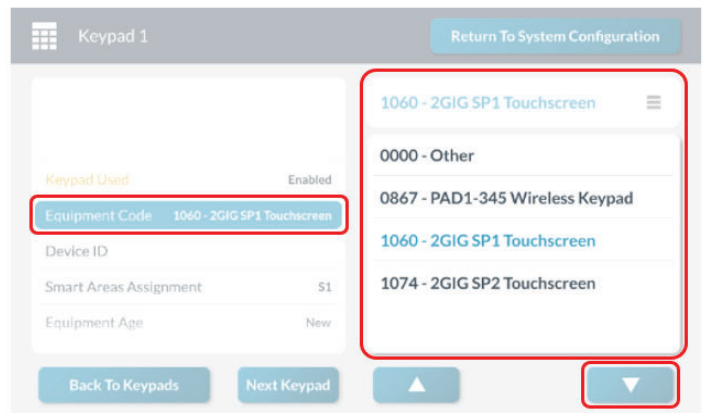

Tip: You can alternatively use the touchscreen keypad to enter the four-digit **Equipment Code**. See "Equipment Codes."

4. Tap ▼.

Step 4A: Pair SP1 or SP2

Pair the SP1 or SP2 keypad to the system. If **SP1** or **SP2** was selected in *Equipment Code*, this option will show as Device ID.

NOTE: If programming a PAD1, the option will show as Serial Number, follow Step 4B.

- » Before Pairing SP1 or SP2 the system and the keypad must both be connected to the same broadband network or keypad must be connect to the systems internal Access Point via WiFi.
- » Before pairing a SP2, make note of the GC3s broadband or Access Point IP address before starting the process.

For more details, see the installation manual of the device.

1. Press **Pair** button.

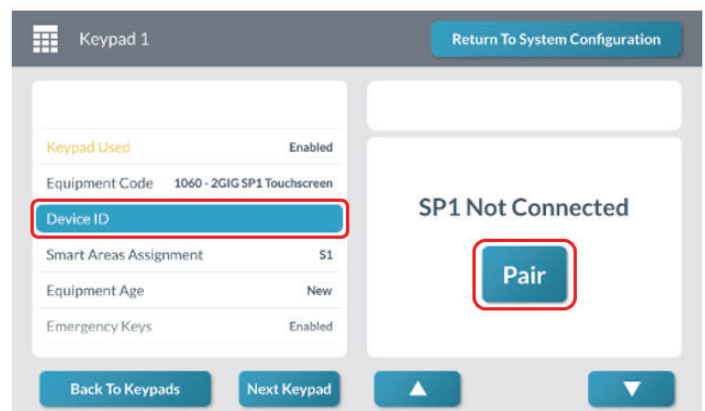

2. Start pairing process on SP1 or SP2 (See SP1/2 installation manual for details).
3. System will show Device ID when paired.
4. Tap ▼.

Step 4B: Enter the PAD1 Serial Number (TX ID)

Next, enter the 7-digit TX ID (this is product's serial number) for the keypad. This is typically affixed to the product and/or its packaging. To enter the number, choose one of these options:

» **Touchscreen Keypad Entry:** Use the touchscreen keypad to manually enter the TX ID into the system.
OR

» **Learning Mode Entry:** Place the GC3 Panel into **Learning Mode** to automatically enter the TX ID into the system.

1. At the **Keypad <###>** screen, highlight **Serial Number**.
2. Place the GC3 Panel into Learning Mode by tapping **Learn**.

<###> Screen—Serial Number

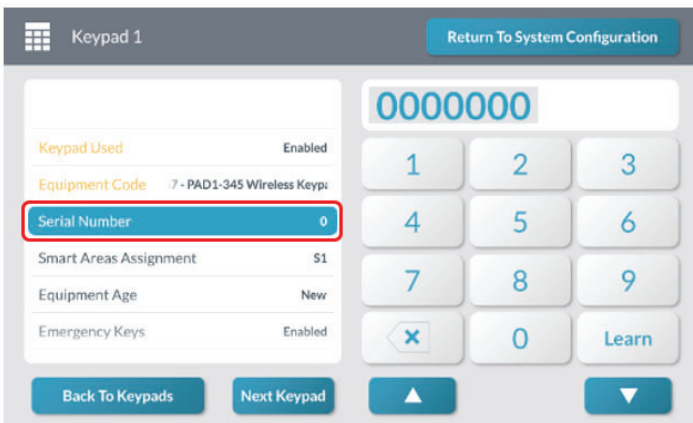

The panel listens for the 7-digit TX ID transmission from the keypad.

Keypad <###> Screen—Listening for TX ID

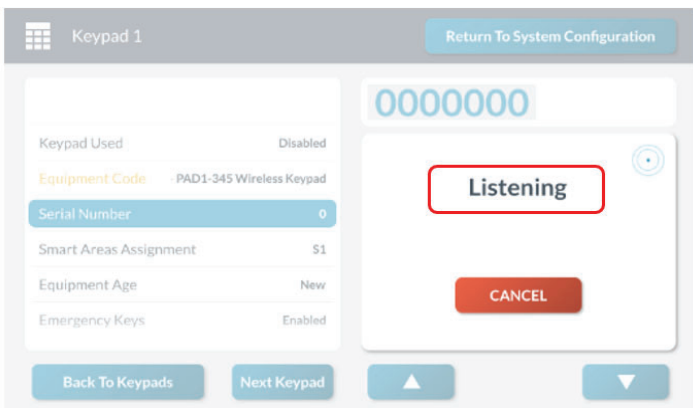

3. Touch and hold any button on the keypad. Consult the *Installation Instructions* that came with the product for information on how to trigger it. When the panel receives the TX ID, the **Sensor Received** message appears.

4. Verify that the TX ID on the touchscreen matches the one on the product.

5. Tap **Accept**.

Keypad <###> Screen—Accept Serial Number

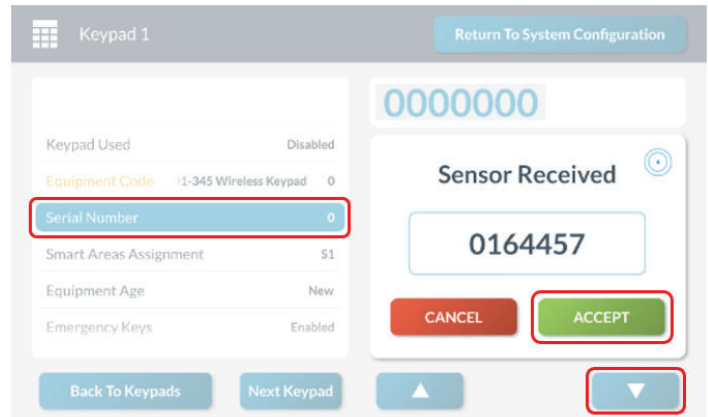

Tip: Instead of placing the GC3 Panel into Learning Mode, you can alternatively use the touchscreen's keypad to manually enter the 7-digit TX ID.

6. Tap ▼.

Step 5: Selecting the Smart Area Assignment

Select a Smart Area Assignment.

1. At the **Keypad Zone<###>** screen, highlight **Smart Areas Assignment**.
2. Under **Smart Areas Assignment**, choose a Smart Area (Partition) for the zone.
3. Tap ▼.

Keypad <###> Screen—Choose Smart Area

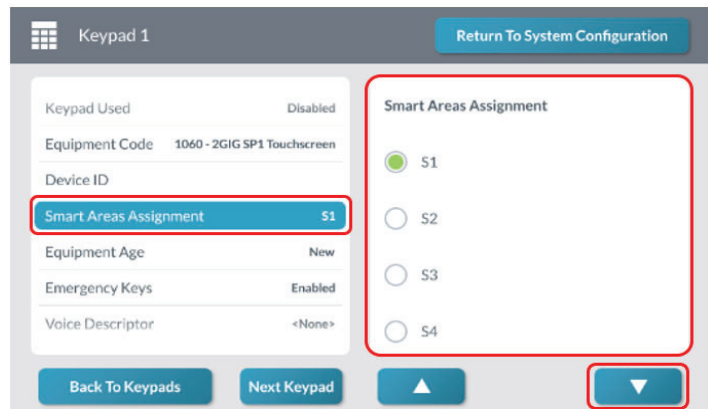

Note: If Smart Areas option is enabled (Q69), keypads can be assigned to a single Smart Area. PAD1 will arm/disarm the assigned Smart Area. SP2 will arm/disarm the assigned Smart Area and display Smart Area status. SP1 will arm/disarm the assigned Smart Area and display that Smart Area status on the home screen and arming/disarming and status of all Smart Areas is available from the **Smart Areas** button on the home screen.

Step 6: Choose the Equipment Age

Choose the equipment age.

1. At the **Keypad <###>** screen, highlight **Equipment Age**.
2. Under **Equipment Age**, choose **New** or **Existing**.

Keypad <###> Screen—Equipment Age

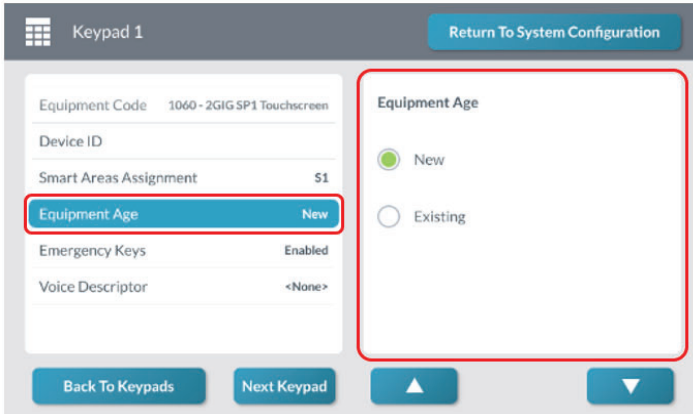

3. Tap ▼.

Step 7: Select Emergency Keys

Next, enable or disable the emergency Panic and Fire keys on the keypad.

1. At the **Keypad <###>** screen, highlight **Emergency Keys** setting is selected.
2. Under **Emergency Keys**, choose **Enabled** or **Disabled**.

Keypad <###> Screen—Emergency Keys

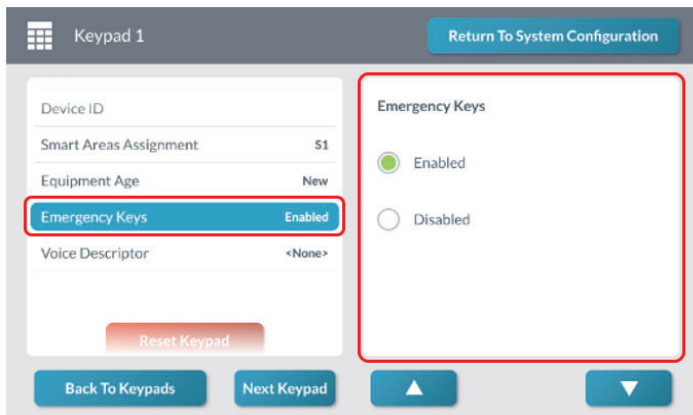

3. Tap ▼.

Step 8: Select a Voice Descriptor

1. At the **Keypad <###>** screen, highlight **Voice Descriptor**.
2. On the touchscreen, tap **Edit Voice Descriptor** to reveal the touchscreen keypad.

Keypad <###> Screen—Edit Voice Descriptor

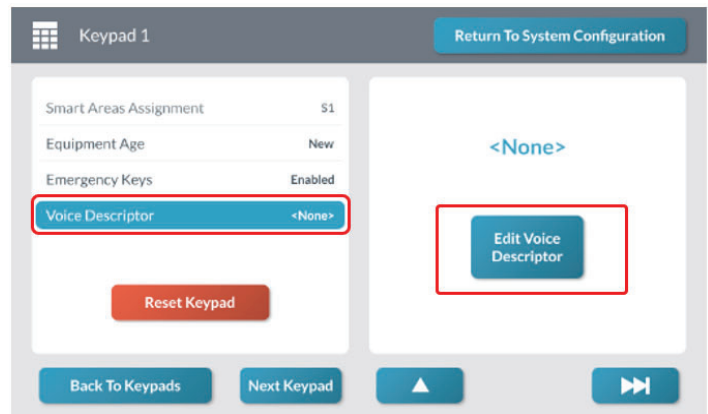

3. On the touchscreen keypad, enter the first few letters of the desired vocabulary word.
4. Tap the matching vocabulary word above the touchscreen keypad to select it.

Touchscreen Keypad—Voice Descriptor Entry

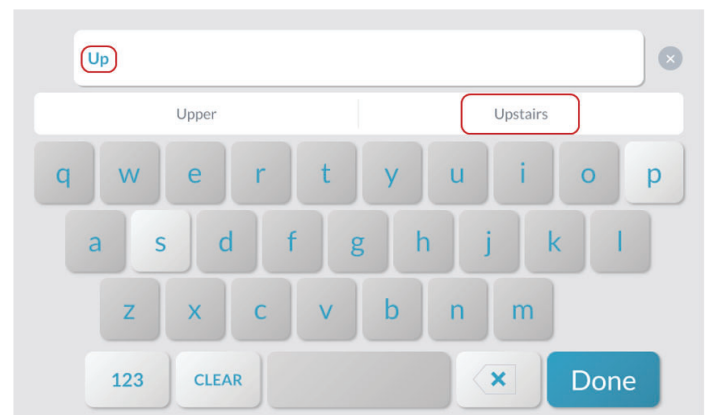

5. Repeat the steps above to enter the desired phrase for the keypad. Add up to six words to create a voice descriptor.
6. Tap **Done**.

Touchscreen Keypad—Voice Descriptor Entry Done

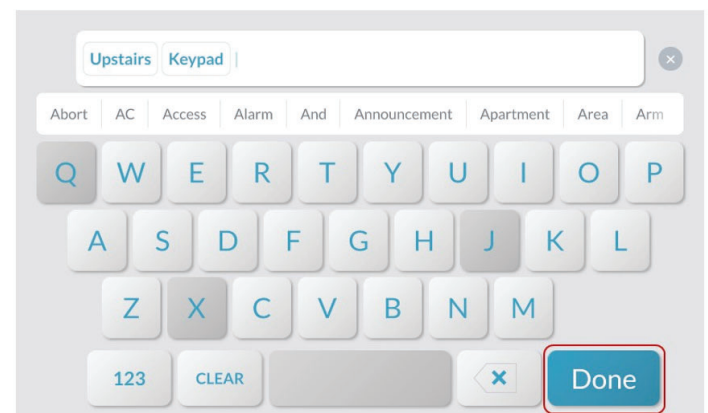

7. Review the voice descriptor.

Keypad <###> Screen—Review Voice Descriptor

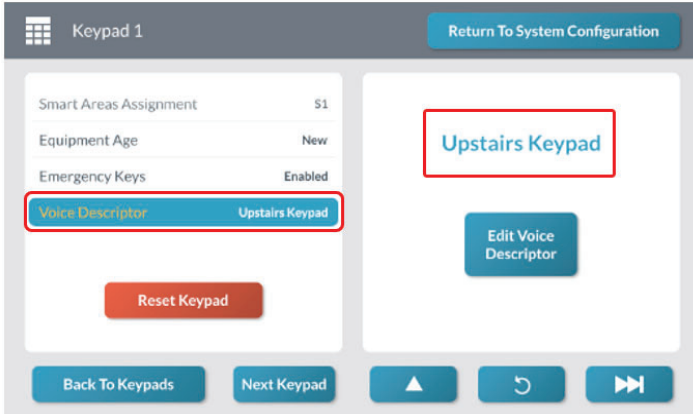

Next Steps

You have finished programming a keypad. You can now choose one of these options:

- » To program another keypad, tap **Next Keypad** repeat the programming steps for another keypad. The system keeps track of all your programming changes and prompts you to permanently save all your changes as a group when you exit the **System Configuration** menu.
- » To program the next keypad, tap **Next Keypad**. This button becomes visible and available only when programming the last setting for a keypad.
- » To erase all of the settings you just programmed for the keypad, tap **Reset Keypad**.
- » To permanently save the settings you just programmed, tap **Return to System Configuration**. Then tap **Save**. At the **Confirm Changes** screen, tap **Save**.

Reset a Zone, Keyfob, or Keypad to the Factory Default Settings

When you reset the GC3 Panel to its factory default settings, the system erases all of the programmed settings for any of the zones, keyfobs, or keypads controlled by the system.

To reset zone, keyfob, or keypad to its factory default setting:

1. At the **Wireless Zones**, **Wired Zones**, **Keyfobs**, or **Keypads** screen, tap the trash can icon next to the desired item.

The following illustration is an example of the **Wireless Zones** screen.

Example—Wireless Zones Screen

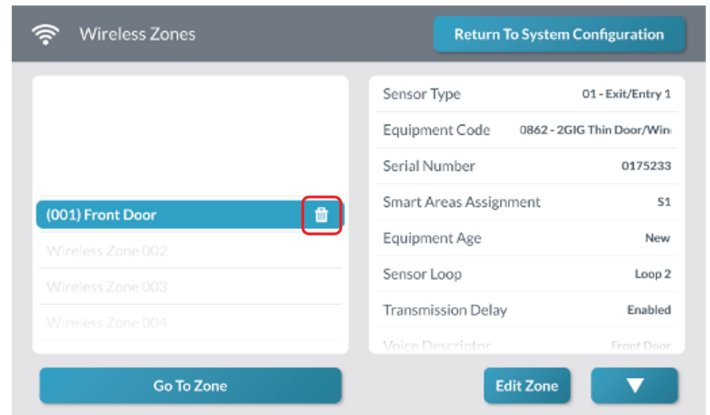

2. At the **Reset Zone** message, verify that you are deleting the desired item. Then tap **Reset**.

Reset Zone Message

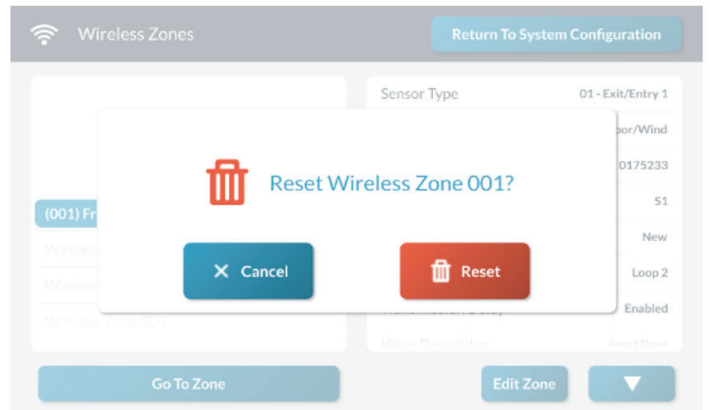

This restores the factory default settings for the specified zone, keyfob, or keypad.

Panel Programming

This section details the Panel Programming questions. A dagger (†) indicates a factory default setting. A double dagger (‡) indicates a default setting for compliance with ANSI/SIA CP-01-2010: Control Panel Standard - Features for False Alarm Reduction.

Q1: Enter installer code (4 digits)

Defines the unique four-digit code for installers to use when accessing the GC3 Panel's Installer Toolbox. See "Navigate to the Installer Toolbox."

Choose one of these options:

- » † 1561: This is the factory default setting.
- » Enter a unique four-digit code. If you change the Installer Code, be sure to remember it so you can access the system later. The Installer Code must be unique from the Master User Code and all other user codes.

Important: To minimize the risk of unwanted persons circumventing the system, 2GIG alarm dealers and professional installers are advised to change the system's default Installer Code to a unique one. This helps to prevent unwanted persons from gaining access to critical programming features of the GC3 Security & Automation System.

Q2: Lock installer programming

This feature prevents system takeovers by locking the installer programming features in the System Configuration menu after 48 hours. The 48-hour lockout timer starts when the installer exits System Configuration mode. To restore access after the 48-hour period, installers must reset the lockout timer using the Cellular Radio Module.

When this feature is enabled, the following programming features are locked out after 48 hours:

- "Q1: Enter installer code (4 digits)" above
- "Q2: Lock installer programming" above
- "Q3: Lock default programming" below,
- "Q7: Remote services provider".

Choose one of these options:

- » † Disabled (Full Access): This turns the feature OFF. Installer programming remains unlocked after 48-hours.
- » No Access: This turns the feature ON. The programming features are fully restricted after 48-hours.
- » Limited Access: This turns the feature ON. The programming features are partially restricted after 48-hours.

Q3: Lock default programming

Prevents system takeovers by limiting the user's ability to restore the GC3 Panel's factory-default settings. There are

two ways to restore the system's factory default settings: Hard Reset and Soft Reset.

Choose one of these options:

- » † Allow Reset of All Defaults: Lets installers restore the factory-default values to the GC3 Panel.
- » Allow Limited Reset of Defaults: Lets installers restore some of the factory-default values, with the exception of "Q1: Enter installer code (4 digits)" above, "Q2: Lock installer programming" above, "Q3: Lock default programming" above, and "Q7: Remote services provider." This setting takes effect 48 hours after the setting is changed, and the countdown timer starts when you exit the System Configuration menu.
- » Do Not Allow Reset of Defaults: Does not let installers restore the factory default values to the GC3 Panel. This setting takes when you exit the System Configuration menu.

Q4: Exit delay, in seconds (45-120)

Configures the number of seconds for the Exit Delay countdown. Different times may be programmed for each Smart Areas. (Smart Areas feature must be enabled (Q69) for values for S2-S4 to affect the system) This is the amount of time occupants have to exit the building through a door after arming the system. The doors programmed as Exit/Entry 1 and Exit/Entry 2 use this timer. When the user arms the system, the countdown starts.

The GC3 Panel beeps once every two (2) seconds during the countdown. For the last 10 seconds, the beeps speed up to warn occupants that they have less than 10 seconds to exit the premises.

Choose one of these options:

- » 45-120 Seconds: Choose a value between 45 and 120 seconds.
- » † ‡ 60 Seconds: For compliance with ANSI/SIA CP-01-2010, the default Exit Delay feature is set to 60 seconds.

NOTE: Arming the system from a remote location with a web-enabled device, such as a computer or smart phone, does NOT initiate the Exit Delay countdown.

Q5: Entry delay 1, in seconds (30-240)

Configures the number of seconds for the Entry Delay 1 timer. Different times may be programmed for each Smart Areas. (Smart Areas feature must be enabled (Q69) for values for S2-S4 to affect the system) This specifies the amount of time occupants have to disarm the system after entering the premises through a door. Typically, the primary entrance programmed as an Exit/Entry 1 door uses this time. When the user enters the premises, the countdown timer starts.

The GC3 Panel beeps once every two (2) seconds during the countdown.

Choose one of these options:

- » 30-240 Seconds: Choose a value between 30 and 240 seconds.
- » † ‡ 30 Seconds: For compliance with ANSI/SIA CP-01-2010, the default Entry Delay 1 feature is set to 30 seconds.

Q6: Entry delay 2, in seconds (30-240)

Configures the number of seconds for the Entry Delay 2 timer. Different times may be programmed for each Smart Area. (Smart Areas feature must be enabled (Q69) for values for S2-S4 to affect the system) This specifies the amount of time occupants have to disarm the system after entering the premises through a door. Typically, secondary entrances that require a slightly longer entry time are programmed as an Exit/Entry 2 door. For example, a back, side, or garage entry door. When a user enters the premises while the system is armed, the Entry Delay 2 countdown starts.

The GC3 Panel beeps once every two (2) seconds during the countdown.

Choose one of these options:

- » 30-240 Seconds: Choose a value between 30 and 240 seconds.
- » † ‡ 45 Seconds: For compliance with ANSI/SIA CP-01-2010, the default Entry Delay 2 feature is set to 45 seconds.

Q7: Remote services provider

Configures the appropriate Remote Services Provider for the system. A Remote Services Provider is the third-party security provider that powers the system's interactive services.

Choose one of these options:

- » None: Does not specify the provider.
- » † Alarm.com: Choose this option if the Remote Services Provider is Alarm.com.

Q8: 2-way voice

Configures the system to automatically turn the GC3 Panel's 2-Way Voice feature ON or OFF after the type of alarm you specify. This gives the GC3 Panel's Cellular Radio Module the ability to automatically dial the

Central Station and connect with an operator after an alarm sounds. Once connected with the Central Station, people on the premises can communicate with the operator using the GC3 Panel's built-in speaker and microphone.

Choose one of these options:

- » Disabled: Turns the feature OFF.
- » † Stay On Line: Turns the feature ON and automatically enables the 2-Way Voice feature after a burglary alarm.

- » Stay On Line, Including Fire & CO Alarms: Turns the feature ON and automatically enables the 2-Way Voice feature after a burglary, fire, and/or carbon monoxide alarm.

When the Control Panel connects with the operator, it will beep once every six seconds. The beep alternates between two tones and indicates the Control Panel is waiting for a session command. If the operator fails to issue a command within three (3) minutes, the call is terminated. Once the operator presses a command option, the beeps will stop and a three (3)-minute audio session will start.

When two (2)-way voice communications have been established, the Central Station operator can use the following telephone keys to control the communications. Each time the operator uses a command key, the session is extended for three (3) additional minutes. During the last minute of communications, the system beeps two (2) times every 15 seconds to indicate that time is running out.

- » Tap 1 to enable Talk mode one (1)-way communication from the Central Station to the premises and allow the operator to talk.
- » Tap 2 to enable VOX mode two (2)-way communications from the Central Station to the premises.
- » Tap 3 to enable Listen mode one (1)-way communication from the premises to the Central Station.
- » Tap 7 to extend the session five (5) minutes without changing the mode of operation.
- » Tap 9 to end the audio session and terminate the call.

Q9: Disable siren after two-way audio

Configures the system to automatically turn the alarm siren ON or OFF after the end of a 2-Way Voice session. For this setting to take effect, "Q8: 2-way voice" above must be enabled.

Choose one of these options:

- » Enabled: Choose this setting if you want the alarm siren to remain OFF after a 2-Way Voice session ends.
- » † Disabled: Choose this setting if you want the alarm siren to resume after a 2-Way Voice session ends.

NOTE: When set to disabled, the alarm siren will only resume after a 2-way voice session when the corresponding alarm bell cutoff time has not expired. See "Q40: Burglary bell cutoff time" and "Q41: Fire bell cutoff time."

Q10: Police emergency key

Configures the system to respond in two (2) ways when a user manually activates a panic alarm on the GC3 Panel. The system can either be set to emit a loud, patterned warning siren or to set off a silent panic alarm with no siren. You can also disable the Panic button so that it is not visible on the GC3 Panel.

Choose one of these options:

- » Disabled: Turns the feature OFF and hides the Panic button from the Alarm screen.
- » † Audible: Turns the feature ON. This makes the Panic button visible on the Alarm screen. The system sounds a loud, patterned warning siren after the user activates a panic alarm.
- » Silent Panic: Turns the feature ON. This makes the Panic button visible on the Alarm screen. The system sounds a silent panic alarm with no warning siren after the user activates a panic alarm.

Q11: Fire emergency key

Configures the system to show or hide the Fire button on the Alarm screen of the GC3 Panel's touchscreen. When set to Audible, the button is visible and the system emits a loud, patterned warning siren when a user manually activates a fire emergency alarm on the GC3 Panel.

Choose one of these options:

- » Disabled: Turns the feature OFF and hides the Fire button from the Alarm screen.
- » † Audible: Turns the feature ON. This makes the Fire button visible on the Alarm screen. The system sounds a loud, patterned warning siren after the user activates a fire alarm.

Q12: Emergency key

Configures the system to show or hide the Emergency button on the Alarm screen of the GC3 Panel's touchscreen. When set to Audible, the button is visible and the system emits a loud, patterned warning siren when a user sets off an emergency alarm on the GC3 Panel.

Choose one of these options:

- » Disabled: Turns the feature OFF and hides the Emergency button from the Alarm screen.
- » † Audible: Turns the feature ON. This makes the Emergency button visible on the Alarm screen. The system sounds a loud, patterned warning siren after the user activates an emergency alarm.

Q13: Quick arming

Turns the system's quick arming feature ON and OFF. This feature can be assigned individually for each Smart Area. (Smart Areas feature must be enabled (Q69) for settings for S2-S4 to affect the system) When ON, any occupant can arm the system. When OFF, only persons who know an active, four-digit user code can arm the system.

Choose one of these options:

- » † Enabled: Turns the feature ON and does not require occupants to enter a user code to arm the system.
- » Disabled: Turns the feature OFF and requires occupants to enter an active, four-digit user code to arm the system.

Q14: Auto stay

Turns the system's Auto Stay feature ON and OFF. This feature can be assigned individually for each Smart Area. (Smart Areas feature must be enabled (Q69) for settings for S2-S4 to affect the system) When ON, the system monitors the Exit Delay doors after the user arms the system in Away Mode at the GC3 Panel. If no one exits that door before the Exit Delay countdown expires, the system automatically arms itself in Stay Mode. See "Q4: Exit delay, in seconds (45-120)." This setting does not go into effect when arming the system in Away Mode with a keyfob.

Choose one of these options:

- » † ‡ Enabled: Turns the feature ON. The system monitors the Exit Delay door when the system is armed and if no one exits the door before the Exit Delay countdown expires, the system automatically arms the system in Stay Mode. For compliance with ANSI/SIA CP-01-2010, this feature is enabled by default.
- » Disabled: Turns the feature OFF. The system arms itself in Away Mode at the end of the Exit Delay countdown.

Q15: Exit delay restart

Configures the system to restart the Exit Delay countdown if a user must re-enter the premises through an Exit Delay door during the initial Exit Delay countdown. This feature can be assigned individually for each Smart Area. (Smart Areas feature must be enabled (Q69) for settings for S2-S4 to affect the system) This is useful when a user arms the system, exits the premises, and then needs to quickly enter/exit the premises before the countdown expires. As long as the user exits the premises during the Exit Delay Restart countdown, there is no need to disarm and re-arm the system. When this feature is turned ON, the Exit Delay timer will restart one (1) time.

Choose one of these options:

- » † ‡ Enabled: Turns the feature ON. If the user exits and then re-enters the premises before the Exit Delay countdown expires, the Exit Delay countdown restarts before the system is armed. For compliance with ANSI/SIA CP-01-2010, this feature is enabled by default
- » Disabled: Turns the feature OFF.

NOTE: When the Exit Delay Restart feature is enabled on the system and the user arms the

system with the Silent Exit feature enabled, the system will restart the exit countdown using the Silent Exit timer, instead of the Exit Delay timer.

NOTE: When the Exit Delay Restart feature is enabled on the system and the user triggers the Exit Delay Restart feature, the Quick Exit button is disabled.

Q16: Allow quick exit

Configures the system to allow users to quickly exit the premises while the system is armed in Stay Mode. When this feature is turned ON and a user taps Arm Stay, a Quick Exit button appears on the System Armed screen. When a user taps Quick Exit, the system starts the Exit Delay countdown and the user must exit the premises before the countdown expires. After the countdown expires, the system automatically re-arms itself in the specified arming mode.

Choose one of these options:

- » † Enabled: Turns the feature ON. This enables the Quick Exit button on the System Armed screen.
- » Disabled: Turns the feature OFF.

NOTE: The Quick Exit button is not available on the System Armed screen when the user invokes the Exit Delay Restart feature. See “Q15: Exit delay restart.”

Q17: Quick bypass

Configures the system to allow users to bypass a sensor without prompting the user to enter a user code. This feature can be assigned individually for each Smart Area. (Smart Areas feature must be enabled (Q69) for settings for S2-S4 to affect the system) Typically, this feature is disabled, so a user must enter a valid user code before bypassing a sensor.

Choose one of these options:

- » Enabled: Turns the feature ON.
- » † Disabled: Turns the feature OFF.

Q18: Alert on disarm with keyfob after alarm

Configures the system to activate a unique sound when the system in the alarm state is disarmed by a keyfob. The unique sound is four (4) beeps from the GC3 Panel's speaker and four (4) chirps from an external alarm sounder (if installed).

Choose one of these options:

- » Enabled: Turns the feature ON. The system emits the unique sound.
- » † Disabled: Turns the feature OFF.

Q19: Keyfob arm/disarm confirmation

Configures the system to activate a unique sound when the system is armed/disarmed with a keyfob. This feature can be assigned individually for each Smart Area. (Smart

Areas feature must be enabled (Q69) for settings for S2-S4 to affect the system) When enabled, the GC3 Panel's speaker emits one (1) beep when arming and two (2) beeps when disarming the system with a keyfob. If an external alarm sounder is installed the system sounds one (1) chirp when arming and two (2) chirps when disarming the system.

Choose one of these options:

- » Enabled: Turns the feature ON. The system emits the unique sound.
- » † Disabled: Turns the feature OFF. The system does not emit the unique sound.

Q20: Keyfob/remote arming mode on system not ready

Defines how the system behaves when the system is armed remotely while sensors are open.

Choose one of these options:

- » † Auto-Bypass with Zone Participation on Restore: Automatically bypasses all open sensors when the system is remotely armed and, while armed, automatically removes the bypass if the sensor is restored to its normal state.
- » Auto-Bypass: Automatically bypasses all open sensors when the system is remotely armed.
- » Arm Only When System Ready: Does not allow the system to arm remotely when sensors are open.

Q21: Z-Wave feature

Configures the system to show or hide the Smart Home Controls button on Home screen of the touchscreen. When this feature is enabled, it provides users with access to the smart devices on the network, as well as with the ability to edit scenes and rooms.

Choose one of these options:

- » Disabled and Hidden: Hides the Smart Home Controls button on the Home screen.
- » Disabled but Visible: Shows the Smart Home Controls button on the Home screen. When a user taps the button, the This feature is not currently activated message displays.
- » Enabled with Local Scenes Hidden: Shows the Smart Home Controls button, feature is enabled, and Tile for Scenes is hidden.
- » † Enabled: Shows the Smart Home Controls button on the Home screen. Users can operate smart devices from the touchscreen or remotely.

Q22: Smart Home Controls require master code

Configures the system to prompt the user for an active, four-digit user code when attempting to access the Smart Home Controls menu (if enabled). See “Q21: Z-Wave feature “ above.

Choose one of these options:

- » Enabled: When a user taps the Smart Home Controls button, the Enter Your Code to Access Smart Home
- » Controls screen appears.
- » † Enabled: Opens the Smart Home Controls menu, without prompting the user for a code.

Q23: Master user can access Z-Wave setup

Configures the system to allow persons who know the system's Master User Code to gain access to the System Settings > Smart Home Settings menu.

Choose one of these options:

- » Enabled: This makes the Smart Home Settings button available in the System Settings menu after entering the Master User Code.
- » † Disabled: This grays out the Smart Home Settings button and makes it unavailable in the System Settings menu.

Q24: Temperature display units

Specifies the temperature scale used by the system to display weather forecasts on the touchscreen.

NOTE: Weather forecasts are only available on the GC3 Panel when enabled by the service provider.

Choose one of these options:

† Fahrenheit: Displays information using the Fahrenheit temperature scale.

Celsius: Displays information using the Celsius temperature scale.

Q25: Swinger shutdown count (1-6)

Specifies the swinger shutdown count for burglary protection zones. This defines the maximum number of times a zone's sensor can activate (i.e., "trip") an alarm during a single arming session. For example, if the count is set to two (2) trips, a window contact sensor would be permitted to trip the alarm a maximum of two (2) times during a single arming session.

Choose one of these options:

- » 1-6 Trips: Use the touchscreen's numeric keypad to specify a value between one (1) and six (6) trips.
- » † ‡ 2 Trips: For compliance with ANSI/SIA CP-01-2010, this is the default setting.

Q26: Cross sensor zones 99-100

Defines the alarm verification requirement for a cross sensor zone. A cross sensor zone is comprised of two wireless sensors and both sensors must be violated before the system activates the alarm. This means that before a cross sensor zone can activate an alarm, the sensors for both Wireless Zone 99 and Wireless Zone 100 must be violated.

If only one of the two sensors in the cross sensor zone is violated, the system automatically transmits a trouble report

about the violated sensor to the Central Station. If both sensors in the cross zones are violated within the amount of time specified in "Q27: Cross sensor timeout, in seconds (10-120)," the system activates an alarm and also transmits an alarm report to the Central Station.

NOTE: Carbon Monoxide Detectors and Smoke/Heat Alarms cannot be used in cross sensor zones.

Choose one of these options:

- » Enabled: Turns the feature ON. The system transmits a trouble report to the Central Station when one sensor in a cross sensor zone is violated and sets off an alarm when both sensors are violated.
- » † Disabled: Turns the feature OFF.

Q27: Cross sensor timeout, in seconds (10- 120)

Defines the maximum number of seconds it takes the system to activate an alarm when both sensors in a cross sensor zone are violated. The value you define here specifies the maximum amount of time that can pass between the violation of sensors programmed for Wireless Zone 99 and Wireless Zone 100. If both sensors are violated within the amount of time specified here, the system activates an alarm. If only one of the sensors is violated during the timeout interval, the system transmits a trouble report to the Central Station and does not activate an alarm.

NOTE: For the timeout to affect the system, the Cross Sensor Zones feature must also be enabled on the system. See "Q26: Cross sensor zones 99-100."

You have these options:

- » † 10 Seconds: Defines the cross sensor time interval as 10 seconds.
- » 1- 120 Seconds: To extend the timeout interval, the installer programs a value between 1 to 120 seconds.

Q28: Siren supervision time

Configures the system to supervise the wire between an external alarm sounder (if installed) and the GC3 Panel. In the event that the supervised wire is cut, the system waits the number of seconds specified here and then displays a trouble alert on the GC3 Panel's touchscreen. It also transmits a trouble report to the Central Station. "Connect an External Alarm Sounder."

Choose one of these options:

- » † Disabled: Turns the feature OFF.
- » 15 Seconds: Turns the feature ON. 15 seconds after a wire cut is detected, the system displays a trouble alert on the touchscreen and also transmits a trouble report to the Central Station.

- » 30 Seconds: Turns the feature ON. 30 seconds after a wire cut is detected, the system displays a trouble alert on the touchscreen and also transmits a trouble report to the Central Station.
- » 45 Seconds: Turns the feature ON. 45 seconds after a wire cut is detected, the system displays a trouble alert on the touchscreen and also transmits a trouble report to the Central Station.

Q29: CS lack of usage notification time, in days (0-255)

Configures the system to monitor itself for lack of usage. If the system is not armed for the number of days you specify here, an inactivity report is sent to the Central Station.

Choose one of these options:

- » 0 Days: Turns this feature OFF.
- » 1-255 Days: Turns this feature ON and transmits an inactivity report to the Central Station after the specified number of days.
- » † 7 Days: Turns this feature ON and transmits an inactivity report to the Central Station after seven (7) days of inactivity.

Q30: Radio modem network failure time, in minutes (0-255)

Configures the system to display a trouble alert on the touchscreen when the system loses its cellular radio network connection. The number of minutes you specify here defines the amount of down time that must pass before the system issues a trouble alert report. Once network service is restored for five (5) minutes, the trouble alert condition automatically clears itself.

Choose one of these options:

- » 0 Minutes: Turns the feature OFF. The system does not issue a trouble alert
- » 1-255 Minutes: Turns the feature ON. Use the touchscreen's numeric keypad to enter the number of minutes between 1 and 255.
- » † 30 Minutes: Turns the feature ON and issues a trouble alert on the GC3 Panel after 30 minutes of down time.

Q31: Radio network failure causes trouble

Configures the system to display a trouble alert on the touchscreen when it logs a trouble alert condition with the cellular network connection. The GC3 Panel will display an alert message on the touchscreen after the number of minutes specified in "Q30: Radio modem network failure time, in minutes (0-255)" above expires.

Choose one of these options:

- » † Enabled: Turns the feature ON. The GC3 Panel display a visual trouble indicator after a cellular radio network failure.
- » Disabled: Turns the feature OFF. The GC3 Panel will not display a visual indicator after a cellular radio

network failure.

NOTE: Regardless of the setting selected here, a radio network failure will always be logged in the System History.

Once the network connection is restored, the system automatically clears the visual indicator. A record of the trouble alert condition is stored in the **System History**.

Q32: Radio network failure reports

Configures the system to transmit a trouble report to the Central Station when the system detects a cellular radio network failure.

Choose one of these options:

- » † Enabled: Turns the reporting feature ON. The GC3 Panel will transmit a trouble report to the Central Station after a cellular radio network failure.
- » Disabled: Turns the reporting feature OFF. The GC3 Panel will not transmit a trouble report to the Central Station after a cellular radio network failure.

Q33: Broadband network failure time in minutes

Configures the system to display a trouble alert on the touchscreen when the system loses its broadband network connection(WiFi or Ethernet). The number of minutes you specify here defines the amount of down time that must pass before the system issues a trouble alert report. Once the broadband connection is restored for five (5) minutes, the trouble condition automatically clears itself.

Choose one of these options:

- » 0 minutes: Turns the feature OFF. The system does not issue a trouble alert
- » 1-255 minutes: Turns the feature ON. Use the touchscreen's numeric keypad to enter the number of minutes between 1 and 255
- » † 30 Minutes: Turns the feature ON and issues a trouble alert on the GC3 Panel after 30 minutes of down time.

Q34: Broadband network failure causes trouble

Configures the system to display a trouble alert on the touchscreen when it logs a trouble alert condition with the broadband network connection(WiFi or Ethernet). The GC3 Panel will display an alert message on the touchscreen after the number of minutes specified in "Q33: Broadband network failure time, in minutes (0-255)" above expires.

Choose one of these options:

- » † Enabled: Turns the featur ON. The GC3 Panel displays a visual trouble indicator after the broadband network failure.
- » Disabled: Turns the feature OFF. The GC3 Panel will not display a visual indicator after a broadband network failure. Once the network connection is restored, the system automatically clears the visual indicator. A record of the trouble alert condition is stored in the System History.

Q35: Broadband network failure reports

Configures the system to transmit a trouble report to the Central Station when the system detects a broadband network connection(WiFi or Ethernet).

Choose one of these options:

- » † Enabled: Turns the reporting feature ON. The GC3 Panel will transmit a trouble report to the Central Station after a broadband network failure.
- » Disabled: Turns the reporting feature OFF. The GC3 Panel will not transmit a trouble report to the Central Station after a broadband network failure.

Q36: Periodic test, in days (0-255)

Configures the system to automatically transmit periodic test reports about the GC3 Panel's connections to the Central Station at the recurring interval you specify here.

Choose one of these options:

- » 0 Days: Turns the feature OFF. The system does not transmit periodic test reports to the Central Station.
- » 1-255 Days: Turns the feature ON. The system transmits periodic test reports to the Central Station at recurring intervals using the number of days specified here.
- » † 30 Days: Turns the feature ON. The system transmits periodic test reports to the Central Station once every 30 days.

Q37: Alarm cancel time, in minutes (5-255)

Configures the system to transmit a cancellation report to the Central Station whenever an alarm is canceled by a user within the amount of time specified here. To learn how to change the setting for the alarm information that displays on the touchscreen, see "Q38: Alarm cancel display" below.

- » † ‡ 5 Minutes: For compliance with ANSI/SIA CP-01-2010, the minimum required setting is 5 minutes. This can be extended to a greater number of minutes without affecting compliance.
- » 6-254 Minutes: Enter a value between 6 and 254 minutes.
- » 255: To transmit a cancellation report anytime the system is disarmed after an alarm, enter 255.

Q38: Alarm cancel display

Configures the system to display an alert message letting the user know that an alarm cancellation report was sent to the Central Station. The message is displayed if the alarm is canceled within the number of minutes specified in "Q37: Alarm cancel time, in minutes (5-255)."

Choose one of these options:

- » † ‡ Enabled: Turns the feature ON. This displays an alert message notifying the user that an alarm cancellation report was sent to the Central Station. For compliance with ANSI/SIA CP- 01-2010, the default setting for this feature is enabled.

- » Disabled: Turns the feature OFF. The system will not display an alert message when a cancellation report is sent to the Central Station.

Q39: Alarm abort window transmission delay

Configures the amount of time the system will wait to initiate the digital transmission when an alarm condition is triggered. This setting specifies the number of seconds the user has to manually abort the alarm, in the event of a false alarm.

NOTE: The transmission delay can be increased to 45 seconds without affecting ANSI/SIA CP-01 compliance only if the combination of Q39 and "Q5: Entry delay 1, in seconds (30-240)" in "Q6: Entry delay 2, in seconds (30- 240)" does not exceed one (1) minute.

Choose one of these options:

- » 15 seconds: The system waits 15 seconds to initiate the dialer.
- » † ‡ 30 seconds: For compliance with ANSI/SIA CP-01-2010, the default minimum setting is 30 seconds. This setting can be increased to 45 seconds without affecting compliance only if the combination of this setting.
- » 45 seconds: The system waits 45 seconds to initiate the dialer.

Q40: Burglary bell cutoff time

Defines the amount of time the system sounds the burglary alarm after the alarm is activated. After the time set here expires, the alarm siren shuts OFF.

NOTE: This setting only affects the GC3 Panel alarm. It does not affect any auxiliary alarms that may be installed. Typically, auxiliary alarms are set to sound for an unlimited amount of time.

Choose one of these options:

- » † 4 Minutes: The alarm siren shuts OFF after 4 minutes.
- » 8 Minutes: The alarm siren shuts OFF after 8 minutes.
- » 12 Minutes: The alarm siren shuts OFF after 12 minutes.
- » 16 Minutes: The alarm siren shuts OFF after 16 minutes.
- » Unlimited Time: The alarm siren must be shut OFF manually.

Q41: Fire bell cutoff time

Specifies the amount of time a Carbon Monoxide Detector or Smoke/Heat/Freeze Alarm should sound after the alarm is activated. After the time set here expires, the alarm siren shuts OFF.

NOTE: This setting only affects the GC3 Panel alarm. It does not affect any auxiliary alarms that

may be installed. Typically, auxiliary alarms are set to sound for an unlimited amount of time.

Choose one of these options:

- » † 4 Minutes: The alarm siren shuts OFF after 4 minutes.
- » 8 Minutes: The alarm siren shuts OFF after 8 minutes.
- » 12 Minutes: The alarm siren shuts OFF after 12 minutes.
- » 16 Minutes: The alarm siren shuts OFF after 16 minutes.
- » Unlimited Time: The alarm siren must be shut OFF manually.

Q42: Trouble doesn't sound at night

Prevents audible trouble alerts from waking users during nighttime hours. When this feature is turned ON, audible trouble alerts are suppressed between the preconfigured hours of 10:00 PM - 9:00 AM. This setting does not suppress any other trouble alert features. The system will continue to display trouble alert messages on the touchscreen. It will also continue to transmit trouble reports to the Central Station, as well as to log trouble alerts in the system's Alarm History.

If the reported trouble condition clears on its own or a user acknowledges the condition(s) on the Control Panel before 9:00 AM, no trouble tones will sound after 9:00 AM. However, the trouble condition is recorded in the system's Alarm History.

Choose one of these options:

- » † Enabled: Turns the feature ON.
- » ‡ Disabled: Turns the feature OFF. For compliance with UL 985: Household Fire Warning System Units, this setting must be disabled.

Q43: Z-Wave siren mode

Configures the system to sound any Z-Wave sirens that have been added to the network.

Choose one of the options:

- » † Sound for Burglary and Fire/CO: Configures the system to sound any connected Z-Wave sirens during a burglary, fire, or CO alarm.
- » Sound for Burglary Only: Configures the system to sound any connected Z-Wave sirens during burglary alarms only.

Q44: Open collector #1 output

Defines output mode for the external device connected to the OCL1 position of the GC3 Panel's terminal block. See "Control Panel Wiring Diagram."

NOTE: For compliance with ANSI/SIA CP-01-2010, you must set Open Collector Output #1 to 11 - Follows Internal Sounder Alarm.

NOTE: If you enabled a keyfob auxiliary button to trigger the GC3 Control Panel's Open Collector #1, make sure this question is set to 00 Disabled, "Program a Keyfob."

Choose one of these options:

Code	Open Collector Output
00	Disabled
01	Activated When Armed
02	Activated When Disarmed
03	Activated on FTC (Failure to Communicate)
04	Activated on Siren Supervision
05	Activated on Radio Fault
06	Activated on Burglary Alarm
07	Activated on Fire Alarm
08	Activated on Any Alarm
09	Activated on Any System Trouble
† 11	Follows Internal Sounder Alarm
12	Follows Exit/Entry Beeps

Q45: Open collector #2 output

Defines the output mode for the external device connected to the OCL2 position of the GC3 Panel's terminal block. See "Control Panel Wiring Diagram."

NOTE: The factory default setting for *Open Collector Output #2* is 00-Disabled.

Choose on of these options:

Code	Open Collector Output
00	Disabled
01	Activated When Armed
02	Activated When Disarmed
03	Activated on FTC (Failure to Communicate)
04	Activated on Siren Supervision
05	Activated on Radio Fault
06	Activated on Burglary Alarm
07	Activated on Fire Alarm
08	Activated on Any Alarm
09	Activated on Any System Trouble
† 11	Follows Internal Sounder Alarm
12	Follows Exit/Entry Beeps

Q46: Time to detect AC loss, in minutes

Configures the system to display a trouble alert in response to AC power loss after a specified amount of time has passed. By default, the system is configured to both display and sound a trouble alert when the GC3 Panel is without AC power for 10 minutes. When AC power is restored to the GC3 Panel, the trouble alert condition clears automatically after one (1) minute.

Choose one of these options:

- » 0 Minutes: Turns the feature OFF.
- » † 10 Minutes: The system displays a trouble alert on the touchscreen and sounds a trouble siren when the GC3 Panel is without AC power for 10 minutes.
- » 1-30 Minutes: Enter a value between one (1) and 30 minutes

NOTE: The Time to Detect AC Loss feature also transmits a trouble report to the Central Station. The time at which the trouble report is sent depends on what the installer configured for “Q47: Random AC loss report time” below

Q47: Random AC loss report time

Configures the GC3 Panel to transmit the Central Station a trouble report about AC power loss. When enabled, the system transmits the report at a random time that falls within 45 minutes of the time at which the Time to Detect AC Loss, in Minutes feature was first triggered. See “Q46: Time to detect AC loss, in minutes” on the previous page. When enabled, this feature minimizes network congestion for the Central Station, should a regional area experiencing a widespread power outage affect a large number of GC3 Panel users.

Choose one of these options:

- » † Enabled: Turns the feature ON.
- » Disabled: Turns the feature OFF.

Q48: Programming mode entry reports to CS

Configures the system to transmit programming reports to the Central Station. When enabled, this setting automatically transmits a report to the Central Station when programming mode is started and terminated.

Choose one of these options:

- » Enabled: The system transmits a report to the Central Station.
- » † Disabled: The system does not transmit a report to the Central Station.

Q49: Trouble reports to CS

Configures the system to transmit trouble reports to the Central Station when the system detects that any sensor encounters a trouble condition.

NOTE: This setting does not affect trouble reports caused by Control Panel conditions. It only affects trouble reports caused by sensors.

Choose one of these options:

- » † Enabled: The system transmits a report to the Central Station.
- » Disabled: The system does not transmit a report to the Central Station.

Q50: Trouble restore reports to CS

Configures the system to transmit reports to the Central Station when a sensor’s trouble condition clears.

Choose one of these options:

- » † Enabled: The system transmits a report to the Central Station.
- » Disabled: The system does not transmit a report to the Central Station.

Q51: Manual bypass reports to CS

Configures the system to transmit reports to the Central Station whenever a sensor is manually bypassed by a user.

- » Enabled: The system transmits a report to the Central Station.
- » † Disabled: The system does not transmit a report to the Central Station.

Q52: Bypass restore reports to CS

Configures the system to transmit reports to the Central Station when a bypassed sensor (forced or manually bypassed) is restored.

Choose one of these options:

- » Enabled: The system transmits a report to the Central Station.
- » † Disabled: The system does not transmit a report to the Central Station.

Q53: AC loss reports to CS

Configures the system to transmit reports to the Central Station if the GC3 Panel loses AC power. When enabled, this setting waits the number of minutes specified in “Q46: Time to detect AC loss, in minutes” on the previous page. If “Q47: Random AC loss report time” above is enabled, the report will be sent at a random time of up to 45 minutes after the power loss event.

- » † Enabled: The system transmits a report to the Central Station.
- » Disabled: The system does not transmit a report to the Central Station.

When the system loses AC power, a “Power Lost” message appears on the touchscreen and the system icon state changes to show that the GC3 panel is not operating on AC power.

Q54: AC restore reports to CS

Configures the system to transmit a report to the Central Station when AC power is restored to the GC3 Panel. When enabled, AC power must be restored for one (1) minute before the trouble condition clears from the system.

You have these options:

- » † Enabled: The system transmits a report to the Central Station. If “Q47: Random AC loss report time” above is enabled, the report will be sent at a random time up to 45 minutes after the trouble conditions clears.
- » Disabled: The system does not transmit a report to the Central Station.

Q55: System low battery reports to CS

Configures the system to transmit low battery reports about the GC3 Panel to the Central Station.

Choose one of these options:

- » † Enabled: The system transmits a report to the Central Station.
- » Disabled: The system does not transmit a report to the Central Station.

Q56: System low battery restore reports to CS

Configures the system to transmit a report to the Central Station after a low battery condition on the GC3 Panel is restored.

Choose one of these options:

- » † Enabled: The system transmits a report to the Central Station.
- » Disabled: The system does not transmit a report to the Central Station.

Q57: RF low battery reports to CS

Configures the system to transmit low battery reports about the system’s sensors and peripherals to the Central Station.

Choose one of these options:

- » † Enabled: The system transmits a report to the Central Station.
- » Disabled: The system does not transmit a report to the Central Station.

Q58: Sensor low battery restore reports to CS

Configures the system to transmit a report to the Central Station after a low battery condition for a sensor is restored.

Choose one of these options:

- » † Enabled: The system transmits a report to the Central Station.
- » Disabled: The system does not transmit a report to the Central Station.

Q59: System disarmed reports to CS

Configures the system to transmit a report to the Central Station when the system is disarmed by a user. The report includes the keyfob or user code that disarmed the system.

Choose one of these options:

- » Enabled: The system transmits a report to the Central Station.
- » † Disabled: The system does not transmit a report to the Central Station.

Q60: System armed reports to CS

Configures the system to transmit a report to the Central Station when the system is disarmed by a user. The report includes the keyfob or user code that disarmed the system.

Choose one of these options:

- » Enabled: The system transmits a report to the Central Station.
- » † Disabled: The system does not transmit a report to the Central Station.

Q61: Alarm restore reports to CS

Configures the system to transmit reports to the Central Station after an alarm, either when the Bell Cutoff Time expires or when the system is disarmed.

You have these options:

- » Enabled: The system transmits a report to the Central Station. Depending on the number of trips set for a cross sensor zone, the feature works as follows:
 - » If enabled and “Q25: “ on page 1 is set to two (2) trips, the system transmits a report when the triggering sensor is closed (i.e., in its normal state) at the Bell Cutoff Time or if the sensor is closed after the Bell Cutoff Time.
 - » If enabled and “Q25: “ on page 1 is set to one (1) trip, the system transmits a report only if the sensor is closed at the time the system is disarmed. Reports are not sent if a sensor is in swinger shutdown until the time of disarm and the sensor is closed.
- » † Disabled: The system does not transmit a report to the Central Station.

Q62: Smart test reports

Configures the system to transmit smart test reports to the Central Station. A smart test report is designed to reduce incoming network traffic for the Central Station. When enabled in combination with “Q36: Periodic test, in days (0-255),” all non-test reports occurring during normal operations will restart the periodic test report timer (for example, alarm, restore, trouble, etc.). Periodic test reports are only sent when the GC3 Panel has not reported in any way to the Central Station.

Choose one of these options:

- » Enabled: The system transmits a report to the Central Station.
- » † Disabled: The system does not transmit a report to the Central Station.

Q63: RF jam causes trouble

Configures the system to activate a trouble condition when the GC3 Panel’s wireless receiver detects that one of the system’s RF transmitters is causing an RF jam. For this setting to go into affect, you must also enable “Q49: Trouble reports to CS” on the previous page.

Choose one of these options:

- » Enabled: The system detects RF jamming.
- » † Disabled: The system does not detect RF jamming.

Q64: System tamper causes trouble

Configures the system to activate a trouble condition if one of the GC3 Panel’s tamper switches (wall tamper switch or cell radio tamper switch) is triggered while the system is disarmed. The system will also activate an alarm condition if a tamper switch is triggered while the system is armed.

You have these options:

- » † Enabled: The system activates a trouble condition.
- » Disabled: The system does not activate a trouble condition.

Q65: Auto unbypass for manual bypass

Manually bypassed sensors can have their bypass automatically removed at disarming or have their bypasses remain in place.

You have these options:

- » † Enabled: Turns the feature ON. The system automatically removes bypasses from manually bypassed sensors when the system is disarmed.
- » Disabled: Turns the feature OFF. Manually bypassed sensors will remain bypassed when the system is disarmed.

Q66: Force bypass reports

Configures the system to transmit a report to the Central Station when a user force-bypasses a sensor while the system is armed.

You have these options:

- » Enabled: The system transmits a report to the Central Station.
- » † Disabled: The system does not transmit a report to the Central Station.

NOTE: Forced bypassed sensors are always recorded in the event log, regardless of the setting of this programming question.

Q67: Event log

Configures the system to define the types of system events that are recorded in the system’s History.

You have these options:

- » Disabled : Does not record events.
- » All Events Except Open/Close/Bypass: Records all events, except sensor opening, closing, and bypassing.
- » All Events Except Open/Close: Records all events, except sensor opening and closing.
- » † All Events: Records all events.

Q68: Allow backlight always on (demo mode)

Configures the system to always leave the touchscreen’s backlight on. This is useful when users want to demonstrate panel features, without the system backlight timing out.

Important: Leaving the backlight ON for extended periods of time may result in image retention. To avoid this, it is recommended that you only enable this feature when the panel is intended for use as a demonstration system.

Choose one of these options:

- » Enabled: The backlight for the touchscreen is always ON.
- » † Disabled: The backlight for the touchscreen dims automatically after 60 seconds of inactivity.

Q69: Smart Areas

Configures “Smart Areas” (partitioning) feature allowing the system to be divided into four separate areas. Once enabled, zones, keyfobs, keypads, and users can be assigned to Smart Areas allowing individual control of each area.

Choose one of these options:

- » Enabled: Smart Areas button will be displayed on GC3 Panel and all SP1 keypads. Zones, Keyfobs, Keypads can be assigned to a single Smart Area. Users can be assigned and control assigned Smart Areas. Smart Areas Settings will allow naming of all four areas.
- » † Disabled: Smart Areas button will not be displayed on the home screen of the GC3 and SP1s. Smart Areas Settings will only display the main system.

NOTE: Programming of Zones, Keyfobs, and Keypads is not restricted and all devices can be programmed and assigned to any of the four Smart Areas but will be inactive if assigned to Smart Area 2-4 until this feature is enabled.

Q70: Main Panel Sounder Follows

Configures the system to allow alarms in all Smart Areas to sound the Main panel.

Choose one of these options:

- » † All Smart Areas: Alarms from any Smart Area will alert and sound at the GC3 Panel.
- » Main Panel Smart Area Only: Only alarms in Smart Area 1 will alert at the GC3 Panel, alarms in Smart Areas 2-4 will only alert on keypads assigned to those areas.

Note: With both options alarms for all Smart Areas are visible by entering the Smart Areas Screen via the Home Screen button.

Q71: Security pin code length

Configures the systems pin code length.

Choose one of these options:

- » † 4 Digits: Installer, Master, and user codes will be 4 digits long.
- » 6 Digits: Installer, Master, and user codes will be 6 digits long.

Restore the Factory Default Settings

You can restore the Control Panel settings back to their factory defaults. There are two (2) reset options: *soft* and *hard*.

NOTE: If changing from 4 to 6-digit pin codes, all existing codes will be appended with "11". The default 6-digit Installer pin code is 156111 and Master 111111.

NOTE: When changing from 6 to 4-digit pin codes all pin codes will be truncated, removing the last 2 digits. If this action causes conflicts, the system will prompt to resolve the conflicts. Conflicts can be resolved by defaulting the user codes or changing the existing pin codes so that no first four digits of the pin codes are the same.

Soft Reset

A soft reset lets you select which settings to restore back to the factory defaults.

To perform a soft reset:

1. Navigate to the **Installer Toolbox** screen.
2. Tap **Restore Defaults**.

3. At the **Restore Defaults** screen select the areas that you would like to restore and tap **Restore to Defaults**.

Restore Defaults Screen

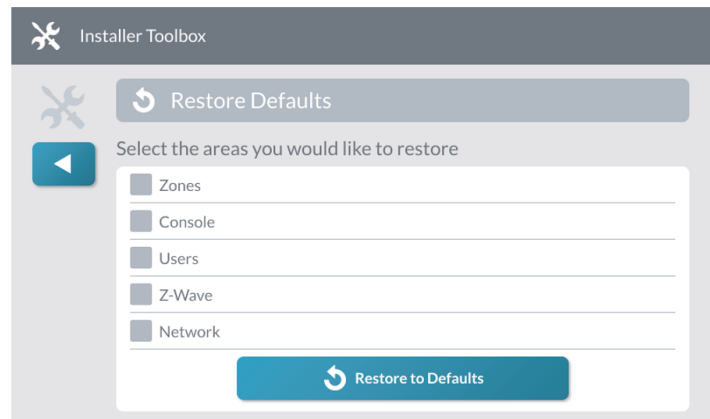

This restores the factory defaults setting for the areas selected and then the system restarts.

Hard Reset

A *hard reset* restores all programming settings back to the factory defaults.

NOTE: Before performing a *hard reset*, Q2: *Lock Installer Programming* must be set to No access or Limited access, and Q3: *Lock Default Programming* must be set to *Allow reset of all defaults*. See "Q2: Lock installer programming," and "Q3: Lock default programming."

To perform a *hard reset*:

1. Remove the Control Panel cover and completely disconnect all power to the Control Panel.
2. On the inside back of the Control Panel, plug in the backup battery.
3. Connect DC power to the Control Panel.
4. Wait until the **Home** and **Emergency** buttons begin flashing.
5. Simultaneously press and hold down the **Home** and **Emergency** buttons. The **Home** and **Emergency** buttons will flash at a faster rate to indicate that the key press was registered.

Release the buttons only after both the Home and Emergency are lit and the Control Panel screen appears.

NOTE: Restoring "Users" will also change Q71 to default setting of 4 digits. Installer pin code and Master pin code will return to the 4-digit defaults.

System Configuration Reference

When programming wireless and wired zones, as well as keyfobs and keypads, installers are required to choose options for a variety of settings. This topic describes each setting and its available options.

Sensor Programming Reference

Required for all wired and wireless zones.

Sensor Types

Sensor Type	Description
(00) Unused	This is the setting for unused sensor numbers that do not have a sensor programmed into them. No system action occurs at any time from this sensor type.
(01) Exit/Entry 1	<p>This sensor type is reserved for doors that are used for exit and entry of the protected premises. When the system is armed in the Stay or Away mode, the exit delay timer starts. There is an exit delay regardless of whether the system is armed in Stay or Away mode. When the exit delay timer expires, the system is fully armed.</p> <p>With the system fully armed, when this type of sensor is triggered, the <i>Entry Delay 1</i> timer starts. The system must be disarmed before the <i>Entry Delay 1</i> timer expires, or an alarm will occur.</p> <p>If the entry delay timer is turned OFF during arming, the exit/entry delay sensors will act as non-delayed instant sensors at the end of the exit delay.</p>
(02) Exit/Entry 2	This sensor type operates the same as the <i>Exit/Entry 1</i> sensor type except that it starts the <i>Entry Delay 2</i> timer. This provides a method of having a longer entry delay on certain openings, such as a garage door, to provide the end user more time to disarm the system.
(03) Perimeter	This sensor type is for perimeter doors and windows that will not be used to enter or exit the protected premises while the system is armed. An instant alarm will occur when this type of sensor is triggered with the system armed in either the Stay or Away mode.

(04) Interior Follower	<p>This sensor type is for interior sensors, such as motion detectors, interior doors, and other sensors that detect human presence inside the protected premises. This type of sensor is called a "follower" due to its action when the system is armed. in the Away mode. After the exit delay expires and the system is armed, if an interior follower sensor is triggered, an instant alarm will occur. If an exit/entry delay sensor is triggered first, the interior follower sensor will also be delayed.</p> <p>Interior follower sensors are always bypassed and not active when the system is armed in Stay mode. This allows the premises to be occupied while still protecting the perimeter.</p>
(05) Day Zone	This sensor type is the same as a perimeter zone, except that when the system is disarmed, a violation displays a trouble alert on the Console's display. This type of sensor is commonly used to protect sensitive areas that require notification and possibly a Central Station trouble report, but not an alarm when the system is disarmed.
(06) 24-Hour Silent Alarm	This sensor type is active independent of the system arming status. The code for silent panic is sent to the Central Station, but for safety, there are no visual or audible indications locally that this sensor type has been triggered.
(07) 24-Hour Audible Alarm	This sensor type is continuously armed 24-hours-a-day. A sensor programmed to this type will trigger a local alarm and the bell output regardless of the mode the system is in. This sensor type is typically used for an audible panic alarm.
(08) 24-Hour Auxiliary Alarm	This sensor type is continuously armed 24-hour-a-day. A sensor programmed to this type will trigger an alarm regardless of the mode the system is in. The bell output will not activate, but the local sounder will continue until it is acknowledged at the Control Panel. This sensor type is typically used for a monitoring device, such as a flood or temperature sensor. There is no time out for the internal sounds; it will continue until a user code is entered.

(09) 4-Hour Fire †	<p>This sensor type is continuously armed 24-hours-a-day. A sensor programmed to this type will trigger the local alarm fire sounder and the bell output regardless of the mode the system is in. This sensor type is typically used for wireless smoke detectors. This sensor type is always active and cannot be bypassed.</p>
(10) Interior with Delay	<p>This sensor type operates as a delayed sensor when the system is armed in the <i>Away</i> mode, and when triggered, will start the <i>Entry Delay 1</i> timer. If the system is armed in Away mode with no Entry Delay (armed instant), this sensor type will trigger an instant alarm.</p> <p>If the system is armed in Stay mode (or Stay mode with no Entry Delay), this sensor type will be bypassed.</p>
(14) 24-Hour Carbon Monoxide †	<p>This sensor type is continuously armed 24-hours-a-day. A sensor programmed to this type will trigger the local alarm pulse sounder and the bell output regardless of the mode the system is in. This sensor type is typically used for wireless carbon monoxide detectors. This sensor type is always active and cannot be bypassed.</p>
(16) 24-Hour Fire Verification †	<p>This sensor type is continuously armed 24-hours-a-day. A sensor programmed to this type can trigger the local alarm fire sounder and the bell output regardless of the mode the system is in. This sensor type is typically used for wireless smoke detectors. This sensor type is always active and cannot be bypassed.</p> <p>For verification, this sensor type must be violated twice in two (2) minutes, or remain violated for 30 seconds. If any other fire sensor (verified sensor type or not) violates within two (2) minutes, both sensors will cause a fire alarm.</p>
(23) No Response Type	<p>This sensor type is a special zone that can be monitored for activity or inactivity by the Central Station. It does not affect security system status.</p>
(24) Silent Burglary	<p>This sensor type is for silent triggering the burglary alarm with perimeter doors and windows that will not be used to enter or exit the protected premises while the system is armed. The Control Panel's sounder and the bell output will not activate.</p> <p>An instant silent alarm will occur when this type of sensor is triggered with the system armed in either the <i>Stay</i> or <i>Away</i> mode.</p>

† Indicates sensor types that are not allowed for hardwired loops.

Sensor Equipment Type

For wireless zones that have been specified as being on one of these equipment types (for example, *04-Interior Follower*, *06-24-Hour Silent Alarm*, *07- 24-Hour Audible Alarm*, *08 24-Hour Auxiliary Alarm*, *10- Interior with Delay*, *23-No Response Type*), installers must also select one of the **Sensor Equipment Types** listed below.

Sensor Equipment Type

Sensor Type	Sensor Equipment Type
(04) Interior Follower	Contact, Motion
(06) 24-Hour Silent Alarm	Contact, Emergency
(07) 24-Hour Audible Alarm	Contact, Emergency
(08) 24-Hour Auxiliary Alarm	Contact, Freeze, Water, Temperature, Emergency
(10) Interior with Delay	Contact, Motion
(23) No Response Type	Contact, Motion
(32) Remote Device	Special Zone with Wireless Repeater
<p>This zone type is selected by the installer when pairing the panel with peripheral devices that can utilize localized troubles (such as RF jam, low battery, tamper, or AC loss detected by the peripheral device). This sensor is continuously active and will cause a trouble at the panel for all problem conditions. When the panel is in an armed state, this sensor type will cause an alarm for TAMPER and RF JAM. All trouble conditions will be sent to the monitoring station if reporting is enabled with the exception of AC LOSS. This will only be displayed at the panel.</p>	

Equipment Code

Required for all wireless zones, keyfobs, and keypads.

Equipment Code

Wireless Zones—Equipment Codes
0000-Other
0862-2GIG Thin D/W (Surface) Contact
0863-2GIG Recessed Door Contact
0869-2GIG PIR with Pet Immunity
0864-2GIG Glass Break Detector
0865-2GIG Outdoor Door/Window Sensor
0895-SMKT2-345 GE Smoke/Heat Detector (USA/Canada)
1058-2GIG Smoke Detector
0872-SMKE1-345 Smoke Detector (USA)
0871-SMKE1-345C Smoke/Heat Detector (Canada)
0868-2GIG Panic Button Remote

0860-CO1-345 CO Detector (USA)
0859-CO1-345C CO Detector (Canada)
1026-2GIG CO Detector
1069-2GIG FireFighter SMKT/CO Listener
0873-2GIG Takeover Module
0637-Honeywell D/W "5816"
0470-HW R-D/W "5818MNL"
0533-HW PIR "5890"
0530-HW PIR "5894PI"
0519-HW Glass Break "5853"
0589-HW Smoke "5808W3"
0557-HW Heat Sensor "5809"
0624-HW Flood Sensor "5821"
0491-HW Panic Pendant "5802MN2"
1061-Tilt Sensor
1062-2GIG Tilt Sensor
1063-2GIG Doorbell
1064-2GIG Bypass Sensor
1065-2GIG Flood Sensor
1067-2GIG Repeater
1070-2GIG F1-345
1071-2GIG PHB-345
1072-2GIG Smoke Ring
0655-Existing Door/Window Contact
0609-Existing Motion Detector
0475-Existing Glass Break Detector
0616-Existing Smoke Detector
0692-Existing CO Detector
0708-Existing Heat Sensor
0556-Existing Flood/Temp Sensor
9999-Alarm.com Image Sensor

Wireless Zones - eSensor Equipment Codes*
2862-eSeries Thin Door/Window Contact
2863-eSeries Recessed Door Contact
2869-eSeries PIR with Pet Immunity
2864-eSeries Glass Break Detector
2058-eSeries Smoke Detector (USA) (Use for all loops (1 2 3).)

2061-eSeries Tilt Sensor
2065-eSeries Flood Sensor
2069-eSeries FireFighter SMKT/CO Listener
2070-eSeries Water Sensor
2860-eSeries CO Detector (USA)
2868-eSeries Panic
2873-eSeries Takeover Module

Keyfobs - eSensor Equipment Code*
2866-eSeries Key FOB

*Note: eSeries sensors are only compatible with the GC3e panel.

Serial Number

Required for all wireless zones.

The serial number is a 7-digit Transmission ID (TXID) that the Control Panel uses to identify a sensor.

Equipment Age

Required for all wireless zones.

Equipment Age

Equipment Age
New
Existing

Normal State

Required for all wired zones.

Normal State

Code	Setting
00	Not Used
01	Normally Closed (N/C)
02	Normally Open (N/O)
03	End-of-Line Resistor (EOLR)

Sensor Loop

Required for all wireless zones.

Sensor Loop

Loop Setting	Use for this sensor type ...
1	Refer to the device manual.
2	Refer to the device manual.
3	Refer to the device manual.

Transmission Delay

Required for wired and wireless zones.

Transmission Delay

Dialer Delay	Choosing this setting ...
Enabled	Turns the Transmission Delay feature ON
Disabled	Turns the Transmission Delay feature OFF

Voice Descriptor

Required for all wireless and wired zones.

Voice Descriptor (System Vocabulary)

Letter	On the touchscreen keypad, enter the first few letters of the Vocabulary Word (or its Numeric Code)
A	Abort (002), AC (003), Access (004), Alarm (005), And (006), Announcement (007), Apartment (266), Area (008), Arm(009), Armed (010), Arming (011), At (012), Attic (013), Audio (014), Auto (015), Automation (016), Auxiliary (017), Away (018)
B	Baby's (019), Back (020), Balcony (256), Basement (021), Bathroom (022), Battery (023), Bedroom (024), Bell (272), Bonus (025), Boy's (273), Break (026), Button (027), Bypass (028), Bypassed (029)
C	Cabinet (030), Camera (274), Cancel (031), Carbon Monoxide (032), Cave (275), Cellar (033), Cellular (034), Cell Radio (035), Center (036), Check (037), Chest (038), Children's (039), Chime (040), Closet (041), Code (042), Communications (043), Computer (044), Control (045), Cool (046), Corner (271), Crawl (047), Current (048)
D	Daughter's (276), Day (049), Deck (258), Degrees (050), Den (051), Detached (259), Detector (052), Dim (053), Dining (054), Disarm (055), Disarmed (056), Dock (057), Door (058), Doorbell (277), Downstairs (059), Driveway (060)
E	East (061), Eight (062), Eighteen (063), Eighty (064), Electric (065), Eleven (066), Emergency (067), Enter (068), Entrance (069), Entry (070), Error (071), Exercise (072), Exit (073), Exit Now (074), Exterior (075), External (076)
F	Failure (077), Family (078), Fan (079), Fifteen (080), Fifty (081), Fire (082), Fire Alert (083), Fire Detector (084), First (085), Five (086), Flood (087), Floor (088), Fluid (089), Foil (090), For (091), Forty (092), Four (093), Fourteen (094), Fourth (095), Foyer (267), Freeze (096), Freezer (097), Front (098), Furnace (099)
G	Game (100), Garage (101), Gas (102), Gate (265), Girl's (278), Glass (103), Glass Break (104), Guest (105), Gun (106)
H	Hall (107), Hallway (108), Hanging (109), Hang Up (110), Heat (111), High (112), Home (113), House (114)
I	Ice (115), Image (279), Image Sensor (280), Inside (116), Instant (117), Interior (118), Intrusion (119), Is (120)
J	-

K	Key (121), Keyfob (122), Keypad (123), Kids' (124), Kitchen (125)
L	Laundry (126), Left (127), Level (128), Library (129), Light (130), Lights (131), Liquor (132), Living (133), Loading (134), Lock (135), Loft (136), Low (137)
M	Main (138), Maintenance (139), Man (281), Master (140), Medical (141), Medicine (142), Menu (143), Middle (144), Monitor (145), Motion (146), Motion Detector (147), Mud (148)
N	Nine (149), Nineteen (150), Ninety (151), No Delay (155), No Entry Delay (156), North (152), Not (153), Not Ready (154), Nursery (157)
O	Off (158), Office (159), On (160), One (161), One Hundred (162), Output (163), Outside (164), Overhead (260)
P	Panel (165), Panic (166), Pantry (167), Patio (168), Perimeter (169), Phone Line (170), Play (171), Police (172), Pool (173), Porch (270), Pound (174), Power (175), Press (176), Previous (177), Pump (178)
Q	-
R	Radio (179), Ready (180), Rear (181), Refrigerator (261), Relay (182), Remote (183), Repeat (184), RF Jam (185), Right (186), Room (187)
S	Safe (188), Second (189), Security (190), Sensor (191), Sensors (192), Service (262), Session (193), Set (194), Seven (195), Seventeen (196), Seventy (197), Shed (198), Shop (199), Side (200), Silent (201), Siren (202), Six (203), Sixteen (204), Sixty (205), Skylight (206), Sliding (207), Smoke (208), Son's (282), Sounder (209), South (210), Space (211), Spare (212), Stairs (213), Star (214), Status (215), Stay (216), Stop (217), Storage (218), Study (219), Sump (220), Sun (283), Sunroom (263), Supervision (221), Switch (286), System (222)
T	Tamper (223), Temperature (224), Ten (225), Terminated (226), Theater (284), Thermostat (227), Third (228), Thirteen (229), Thirty (230), Three (231), To (232), Tool (233), Transmitted (234), Transmitter (235), Trouble (236), Turn (237), TV (268), Twelve (238), Twenty (239), Two (240)
U	Unlock (241), Upper (242), Upstairs (243), User (244), Utility (245)
V	Yard (253)
W	Wall (248), Warehouse (264), Water (249), West (250), Window (251), Wing (285), Wireless (252)
X	-
Y	Yard (253)
Z	Zero (254), Zone (255)

Sensor Reports

Required for all wireless and wired zones.

Sensor Reports

Sensor Reports	Choosing this setting ...
Enabled	Sends reports to the Central Station.
Disabled	Does NOT send reports to the Central Station.

Sensor Supervised

Required for all wireless zones.

Sensor Supervised

Sensor Supervised	Choosing this setting ...
Enabled	Enables the sensor supervision feature.
Disabled	Disables the sensor supervision feature.

Sensor Chime

Required for all wireless and wired zones.

Sensor Chime

Sensor Chime Setting
Disabled
Voice Only
Ding-Dong #1 with Voice
Ding-Dong #2
Ding-Dong #2 with Voice
Ding-Dong #1
Ding-Ding
Ding-Ding with Voice
Ding-Dong #3
Ding-Dong #3 with Voice
Chime #1
Chime #1 with Voice
Chime #2
Chime #2 with Voice

Panel Programming Reference

This table summarizes the system's panel programming questions, the available settings for each question, and each question's factory-default setting.

Panel Programming Questions

Question Number	Question Text	Available Settings	Factory Default Setting
Q1	Enter installer code (4 digits)	Unique 4-Digit Number	1561
Q2	Lock installer programming	Disabled (Full Access) No Access Limited Access	Disabled (Full Access)
Q3	Lock default programming	Allow Reset of All Defaults Allow Limited Reset of Defaults Do Not Allow Reset of Defaults	Allow Reset of All Defaults
Q4	Exit delay, in seconds (45-120)	45-120 Seconds	‡60 Seconds
Q5	Entry delay 1, in seconds (30-240)	30-240 Seconds	‡30 Seconds
Q6	Entry delay 2, in seconds (30-240)	30-240 Seconds	‡45 Seconds
Q7	Remote services provider	None Alarm.com	Alarm.com
Q8	2-way voice	Disabled Stay online Stay online, including fire and CO alarms	Stay online
Q9	Disable siren after two-way audio	Enabled Disabled	Audible
Q10	Police emergency key	Disabled Audible Silent Panic	Audible
Q11	Fire emergency key	Disabled Audible	Audible
Q12	Emergency key	Disabled Audible	
Q13	Quick arming	Enabled Disabled	Enabled
Q14	Auto stay	Enabled Disabled	‡Enabled
Q15	Exit delay restart	Enabled Disabled	‡Enabled
Q16	Allow quick exit	Enabled Disabled	Enabled
Q17	Quick bypass	Enabled Disabled	Disabled

Q18	Alert on disarm with keyfob after alarm	Enabled Disabled	Disabled
Q19	Keyfob arm/disarm confirmation	Enabled Disabled	Disabled
Q20	Keyfob/remote arming mode on system not ready	Auto-Bypass with Zone Participation on Restore Auto-Bypass Arm Only When System Ready	Auto-Bypass with Zone Participation on Restore
Q21	Z-Wave feature	Disabled and Hidden Disabled but Visible Enabled Enabled with Local Scenes Hidden	Enabled
Q22	Smart Home Controls require master code	Enabled Disabled	Disabled
Q23	Master user can access Z-Wave setup	Enabled Disabled	Disabled
Q24	Temperature display units	Fahrenheit Celsius	Fahrenheit
Q25	Swinger shutdown count (1-6)	1-6 Trips	2 Trips
Q26	Cross sensor zones 99-100	Enabled Disabled	Disabled
Q27	Cross sensor timeout, in seconds (10-120)	10-120 Seconds	10 Seconds
Q28	Siren supervision time	Disabled 15 Seconds 30 Seconds 45 Seconds	Disabled
Q29	CS lack of usage notification time, in days (0- 255)	0- 255 Days	7 Days
Q30	Radio modem network failure time, in minutes (0-255)	0- 255 Minutes	30 Minutes
Q31	Radio network failure causes trouble	Enabled Disabled	Enabled
Q32	Radio network failure reports	Enabled Disabled	Enabled
Q33	Broadband network failure time	0-255 Minutes	30
Q34	Broadband network failure causes trouble	Enable Disable	Enabled
Q35	Broadband network failure reports	Enable Disable	Enabled
Q36	Periodic test, in days (0-255)	0-255 Days	30 Days
Q37	Alarm cancel time, in minutes (5-255)	5-255 Minutes	5 Minutes

Q38	Alarm cancel display	Enabled Disabled	Enabled
Q39	Alarm abort window transmission delay	15 Seconds 30 Seconds 45 Seconds	30 Seconds
Q40	Burglary bell cutoff time	4 Minutes 8 Minutes 12 Minutes 16 Minutes Unlimited Time	±4 Minutes
Q41	Fire bell cutoff time	4 Minutes 8 Minutes 12 Minutes 16 Minutes Unlimited Time	±4 Minutes
Q42	Trouble doesn't sound at night	Enabled Disabled	Enabled
Q43	Z-Wave siren mode	Sound for Burglary and Fire/CO Sound for Burglary Only	Sound for Burglary and Fire/CO
Q44	Open collector #1 output	00-Disabled 01-Activated when Armed 02-Activated when Disarmed 03-Activated on FTC 04-Activated on Supervision 05-Activated on Radio Fault 06-Activated on Burglary Alarm 07-Activated on Fire Alarm 08-Activated on Any Alarm 09-Activated on Any System Trouble 11-Follows Internal Sounder Alarm 12-Follows Exit/Entry Beeps	11-Follows Internal Sounder Alarm
Q45	Open collector #2 output	00-Disabled 01-Activated when Armed 02-Activated when Disarmed 03-Activated on FTC 04-Activated on Supervision 05-Activated on Radio Fault 06-Activated on Burglary Alarm 07-Activated on Fire Alarm 08-Activated on Any Alarm 09-Activated on Any System Trouble 11-Follows Internal Sounder Alarm 12-Follows Exit/Entry Beeps	00-Disabled
Q46	Time to detect AC loss, in minutes	0-30 Minutes	10 Minutes
Q47	Random AC loss report time	Enabled Disabled	Enabled
Q48	Programming mode entry reports to CS	Enabled Disabled	Disabled
Q49	Trouble reports to CS	Enabled Disabled	Enabled
Q50	Trouble restore reports to CS	Enabled Disabled	Enabled

Q51	Manual bypass reports to CS	Enabled Disabled	Disabled
Q52	Bypass restore reports to CS	Enabled Disabled	Disabled
Q53	AC loss reports to CS	Enabled Disabled	Enabled
Q54	AC restore reports to CS	Enabled Disabled	Enabled
Q55	System low battery reports to CS	Enabled Disabled	Enabled
Q56	System low battery restore reports to CS	Enabled Disabled	Enabled
Q57	RF low battery reports	Enabled Disabled	Enabled
Q58	Sensor low battery restore reports to CS	Enabled Disabled	Enabled
Q59	System disarmed reports to CS	Enabled Disabled	Disabled
Q60	System armed reports to CS	Enabled Disabled	Disabled
Q61	Alarm restore reports to CS	Enabled Disabled	Disabled
Q62	Smart test reports	Enabled Disabled	Disabled
Q63	RF jam causes trouble	Enabled Disabled	Disabled
Q64	System tamper causes trouble	Enabled Disabled	Enabled
Q65	Auto unbyypass for manual bypass	Enabled Disabled	Enabled
Q66	Force bypass reports	Enabled Disabled	Disabled
Q67	Event log	Disabled All Events Except Open/Close/Bypass All Events Except Open/Close All Events	All Events
Q68	Allow backlight always on (demo mode)	Enabled Disabled	Disabled
Q69	Smart Areas	Enabled Disabled	Disabled
Q70	Main Panel Sounder Follows	All Smart Areas Main Panel Smart Area Only	All Smart Areas

Features to Limit False Alarms

For compliance with *ANSI/SIA CP-01-2010: Control Panel Standard - Features for False Alarm Reduction*, the installer can set a variety of different options designed to limit occurrences of a False Alarm.

ANSI/SIA CP-01-2010 Features to Limit False Alarms

ANSI/SIA CP-01-2010	2GIG System Feature	Installation & Programming Guide
4.2.2.1 Exit Time	Exit Delay	"Q4: Exit delay, in seconds (45-120)" "Q16: Allow quick exit"
4.2.2.2 Progress Annunciation	Exit Delay Announcement	"Q4: Exit delay, in seconds (45-120)"
4.2.2.3 Exit Time Restart	Exit Delay Restart	"Q15: Exit delay restart"
4.2.2.4 Exit Error	Exit Error	See the GC3 User Guide
4.2.2.5 Unvacated Premises	Auto Stay	"Q14: Auto stay"
4.2.3.1 Entry Delay	Entry Delay	"Q5: Entry delay 1, in seconds (30-240)" "Q6: Entry delay 2, in seconds (30-240)"
4.3.2.2 Progress Annunciation	Entry Delay Announcement	"Q1: Enter installer code (4 digits)" "Q1: Enter installer code (4 digits)"
4.3.2.3 Disarm	Disarming Features	See the GC3 User Guide
4.2.4.1 Control Buttons	Keyfob/Remote Arming Mode on System Not Ready.	"Q20: Keyfob/remote arming mode on system not ready"
4.2.4.2 Manual Alarms	Emergency Alarm Features	See the GC3 User Guide
4.2.4.3 System Acknowledgment	Alert Keyfob Disarming After Alarm Keyfob Arm/Disarm Confirmation	"Q18: Alert on disarm with keyfob after alarm" "Q18: Alert on disarm with keyfob after alarm"
4.2.4.4 Remote Arming	Key Fob Arming	"Q18: Alert on disarm with keyfob after alarm"
4.3.4.5 Remote Disarming	Key Fob Arming	"Q19: Keyfob arm/disarm confirmation"
4.2.5.1 Abort Window	Abort Window Dialer Delay	"Q39: Alarm abort window transmission delay"
4.2.5.1.1 Disarm	Abort Window Dialer Delay	"Q36: Periodic test, in days (0-255)"
4.2.5.1.2 Abort	Abort Window Dialer Delay	"Q36: Periodic test, in days (0-255)"
4.2.5.2 Alarm Transmission	Abort Window Dialer Delay	"Q39: Alarm abort window transmission delay"
4.2.5.3 Disarm	Disarm	See the GC3 User Guide
4.2.5.4 Cancel Window	Alarm Cancel Time, Alarm Cancel Display	"Q37: Alarm cancel time, in minutes (5-255)"
4.2.6.1 Use of Duress Feature	User Duress Report	See the GC3 User Guide
4.2.6.2 Duress Code	Duress Code	See the GC3 User Guide
4.2.7 Initiation of Manual Alarms	Panic, Fire, or Emergency Alarm	See the GC3 User Guide
4.3. Cross Zoning	Cross Sensor Zones, Cross Sensor Timeout	"Q26: Cross sensor zones 99-100" "Q27: Cross sensor timeout, in seconds (10-120)"
4.3.2 Swinger Shutdown	Swinger Shutdown Count (1-6)	"Q25: Swinger shutdown count (1-6)" "Q61: Alarm restore reports to CS"
4.3.3 Fire Alarms	Fire & Carbon Monoxide Protection	Sensor Type — (24) Silent Burglary"
4.6.3 System Test	Console Test Sensors Test	"Testing the Installation"

Image Sensor

After Image Sensors have been added to the GC3 Panel in Wireless Zones programming the Image Sensor details will be displayed in *Image Sensor* settings.

1. Navigate to **Installer Toolbox** menu and tap **System Configuration**.

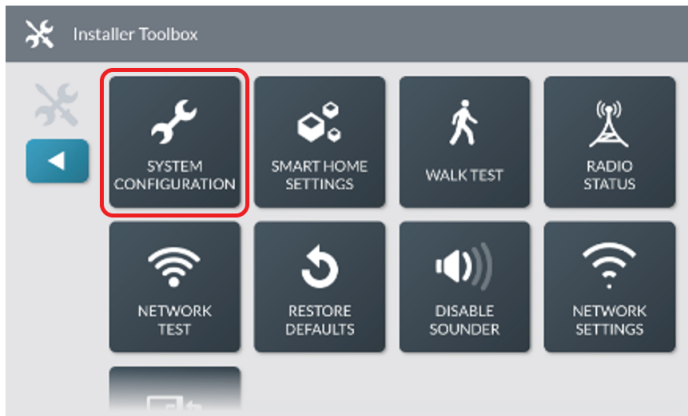

2. Tap **Image Sensor**.

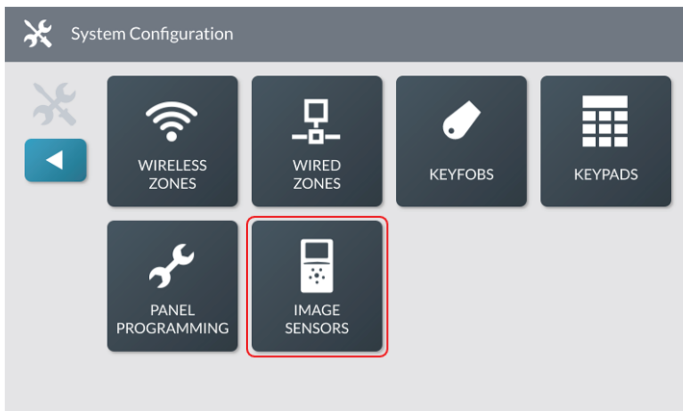

The Image Sensor will be displayed with the following:

- » Zone number
- » MAC address of Image Sensor
- » Firmware Version
- » Battery level
- » Signal Strength
- » Rules
- » Sensitivity

3. Optional: Tap Sensitivity

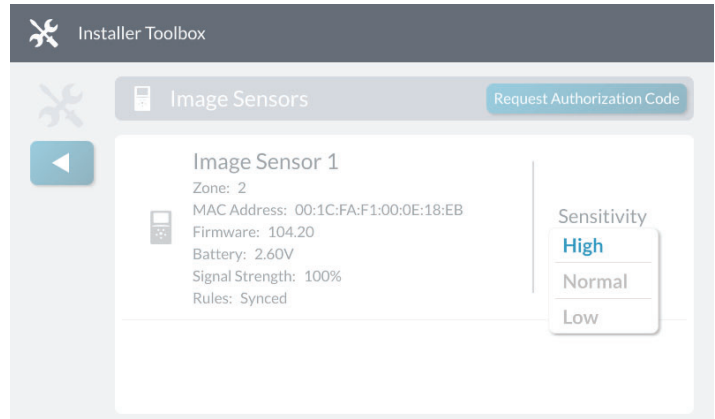

- » Change setting to *High*, *Normal*, or *Low* (default is *Normal*).

Smart Home Settings Menu

Smart Home Settings Menu

Note: This menu is only available to installers.

The **Smart Home Settings** menu provides installers with access to a variety of Z-Wave settings for the GC3 Security & Automation System.

Installers can configure the system to give the Master User permission to access the **Smart Home Settings** menu, users who know the Master User code can access a variety of Z-Wave settings for the GC3 Security & Automation System.

Note: The GC3 Panel ignores any Command_Class_Basic commands it receives from other devices on the Z-Wave network.

Navigate to the Smart Home Settings Menu

To navigate to the Smart Home Settings menu:

4. Navigate to the **Installer Toolbox** menu. See "Navigate to the Installer Toolbox."
5. At the **Installer Toolbox** menu, tap **Smart Home Settings**. This reveals the **Smart Home Settings** menu.

Smart Home Settings Menu

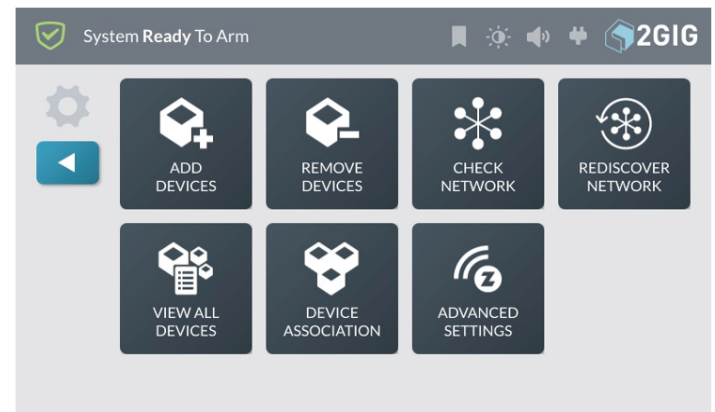

Add a New Device

Tip: Manufacturers may add Z-Wave devices to a network in order to test them. To ensure successful addition of a device to the GC3 Control Panel, remove the new device before adding it to the network. See “Remove a Device.”

To add a Z-Wave device to the network:

1. Navigate to the **Smart Home Settings** menu. See “Navigate to the Smart Home Settings Menu” on the previous page.
2. At the **Smart Home Settings** menu, tap **Add Devices**.

Smart Home Settings—Add Devices

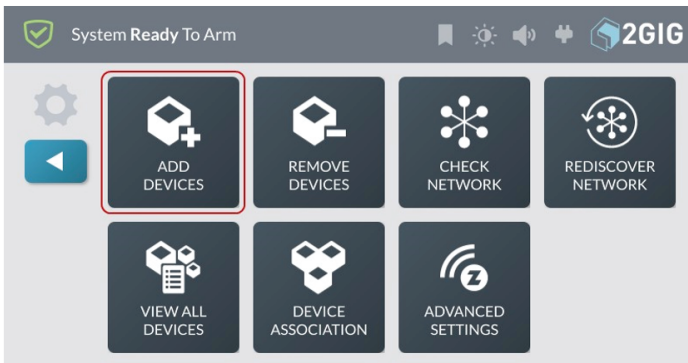

The **Listening for Devices to Add** screen reveals the **Add Devices Now** message.

Listening for Devices to Add—Add Devices Now

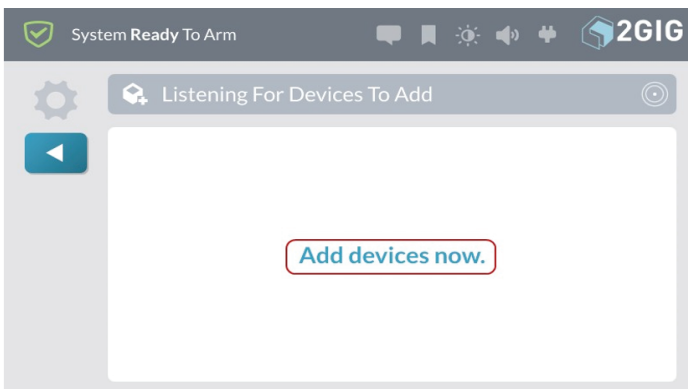

3. Walk to and trigger the device. For example, if you are adding a Z-Wave light bulb, turn the light bulb ON.

Tip: Typically, you can trigger a device on the network by either powering the device OFF/ON, pressing a button once or twice, or flipping a switch on the device. Every device is different.

When the system discovers a device, the **New device found** and **Adding device** message appears.

Adding Device

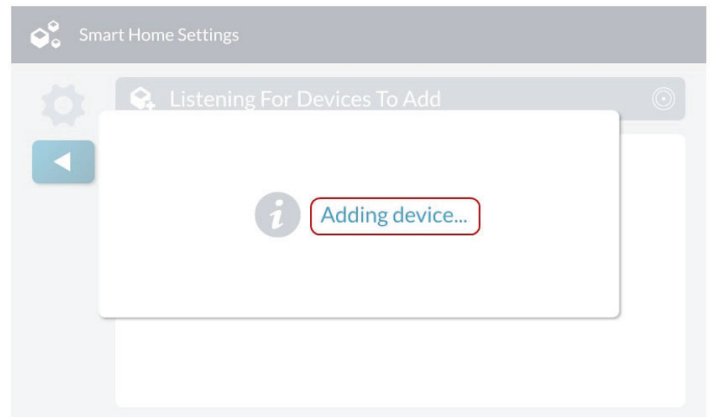

4. At the **New device was added to the system message**, tap **OK**.

New Device was Added to the System Message

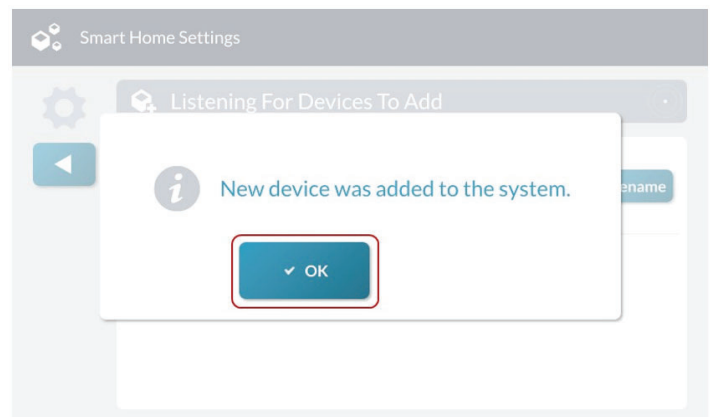

The newly discovered device appears in the **Listening for Devices to Add** screen. Any device information captured during the discovery process appears below the device name.

TIP: The Control Panel issues a double-beep when a device is successfully added to the network.

Listening for Devices to Add—New Device

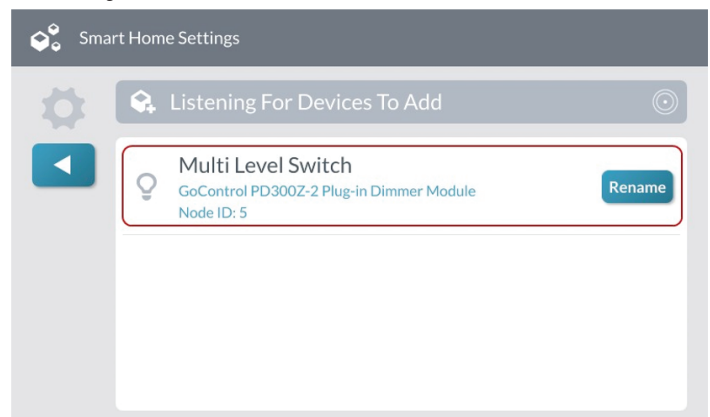

- (Optional) At the **Listening for New Devices to Add** screen, tap **Rename**.

Listening for Devices to Add—Rename

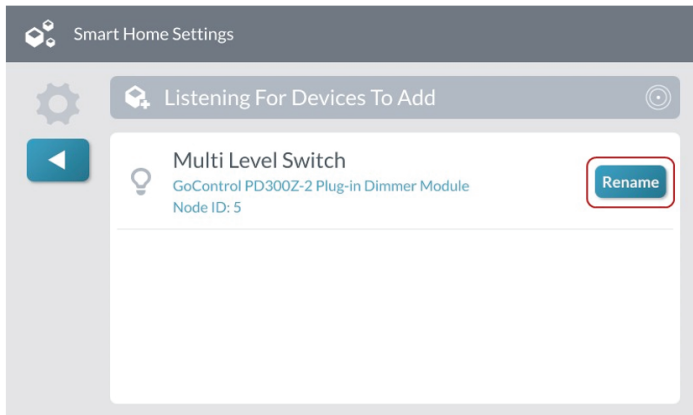

- At the Enter a name for this device screen, use the touchscreen keypad to enter a new device name. For example, enter “**Living Room Dimmer**”.

Enter a name for this device



- Tap **Done**.

The system reveals the new name on the **Listening for Devices to Add** screen.

Listening for Devices to Add—New Device Name

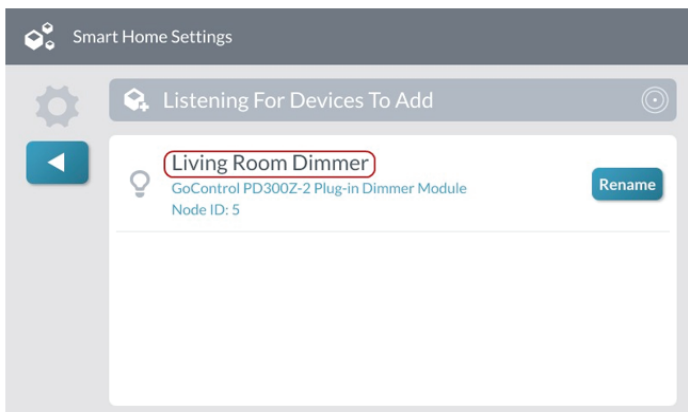

From the **Listening for Devices to Add** screen, you can continue by triggering the next desired device and then renaming it as needed.

- Tap  to return to the **Smart Home Settings** menu.

Remove a Device

To remove a device from the network:

- Navigate to the **Smart Home Settings** menu. See “Navigate to the Smart Home Settings Menu.”
- At the **Smart Home Settings** menu, tap **Remove Devices**.

Smart Home Settings—Remove Devices

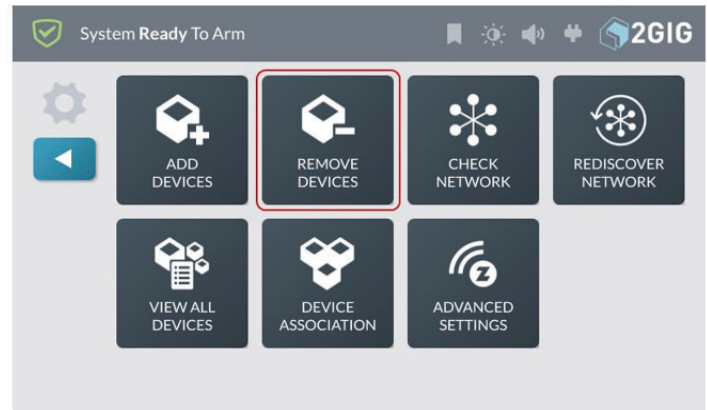

The **Listening for Devices to Remove** screen appears.

Listening for Devices to Remove—Remove Devices Now

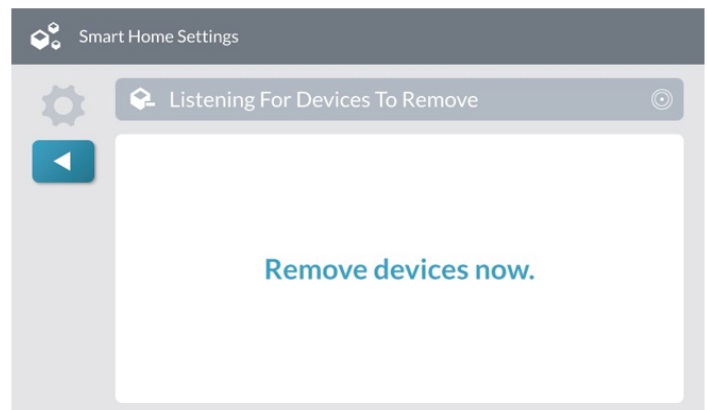

- Walk to and trigger the device on the network. For example, if you are removing a Z-Wave light bulb, turn the light bulb ON.

Tip: Typically, you can trigger a device on the network by either powering the device OFF/ON, pressing a button once or twice, or flipping a switch on the device. Every device is different.

When the system successfully removes the device, it appears on the **Listening for Devices to Remove** screen.

Listening for Devices to Remove—Device Removed

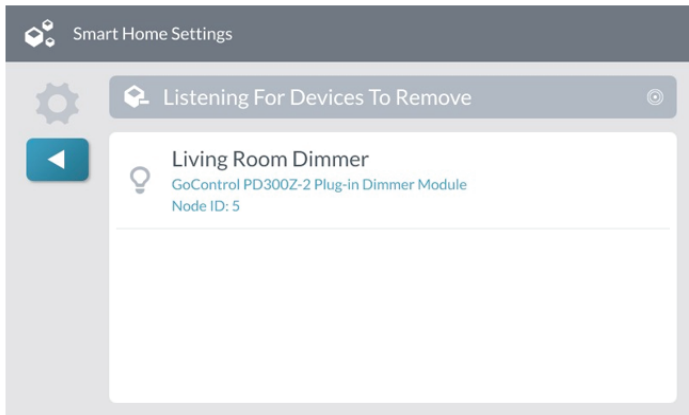

Tip: The Control Panel issues a double-beep when a device is successfully removed to the network.

4. Tap  to return to the **Smart Home Settings** menu.

Check the Network

Use the **Check Network** feature to scan the smart home network for unresponsive nodes. This can take several minutes and some of the smart home functions will be unavailable until the check is complete.

To perform a network check:

1. Navigate to the **Smart Home Settings** menu. See “Navigate to the Smart Home Settings Menu.”
2. At the **Smart Home Settings** menu, tap **Check Network**.

Smart Home Settings—Check Network



3. At the **Check Network** screen, tap **Start**.

Check Network—Start

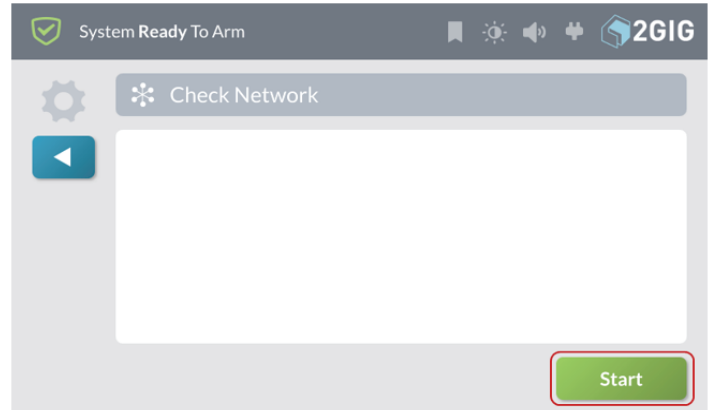

The system scans the network for unresponsive nodes and indicates the status of each scanned node.

Check Network—Status

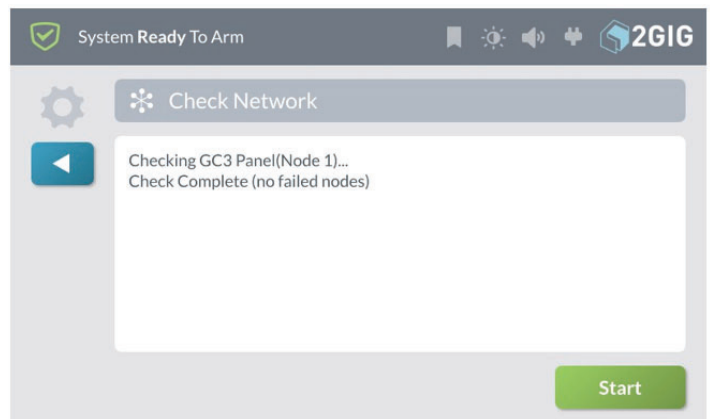

4. When the Check Network is complete you can see the status of nodes in the network.
5. Tap  to return to the **Smart Home Settings** menu.

Rediscover the Network

After adding or removing devices from the network, the final step is to rediscover the network. This updates the system’s communication routes so it communicates with the newly added and previously added Z-Wave devices.

To rediscover the network:

1. Navigate to the **Smart Home Settings** menu. See “Navigate to the Smart Home Settings Menu.”

- At the **Smart Home Settings** menu, tap **Rediscover Network**.

Smart Home Settings—Rediscover Network



- At the **Rediscover Network** screen, tap **Start**.

Rediscover Network—Start

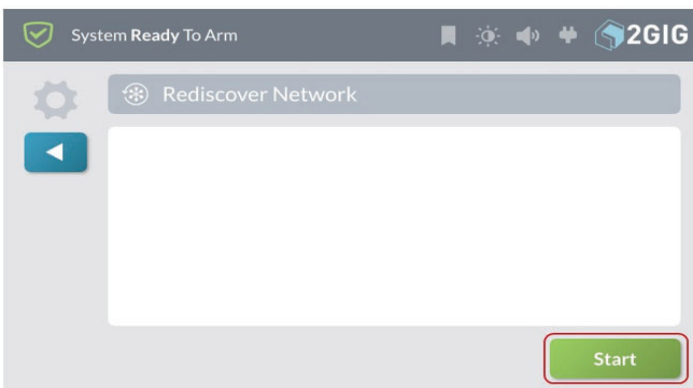

While the system is rediscovering the network it displays the status of each node as it is checked.

Rediscover Network—Status

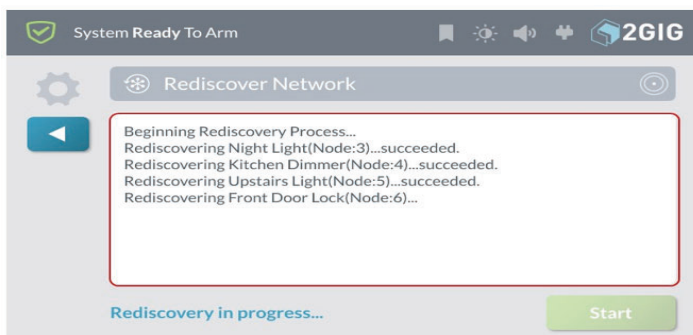

When the rediscovery is complete, the **Rediscover Network** screen with the **Start** button (shown above) appears again.

View All Devices

The View All Devices function lists all Z-Wave devices in the Control Panel network and provides the following options, depending on the type and current status of a device:

- » Configure
- » Hide/Unhide
- » Identify
- » Remove
- » Rename
- » Replace

To view all network devices and access these options:

- Navigate to the **Smart Home Settings** menu. See “Navigate to the Smart Home Settings Menu.”
- At the **Smart Home Settings** menu, tap **View All Devices**.

Smart Home Settings—View All Devices

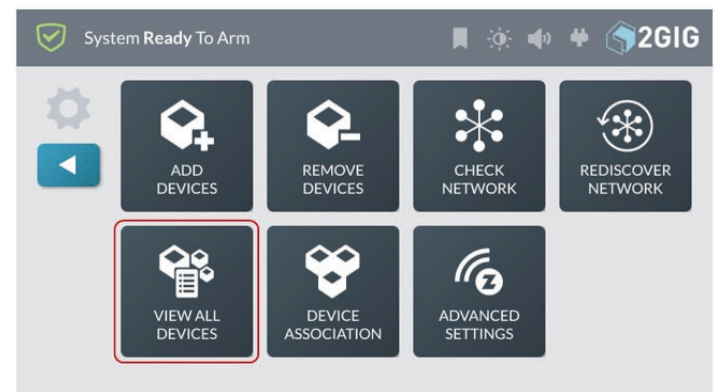

- At the **Smart Home Devices** screen, review the list of devices. If you have added several devices, you can swipe up and down to move through the list.

Smart Home – View All Devices

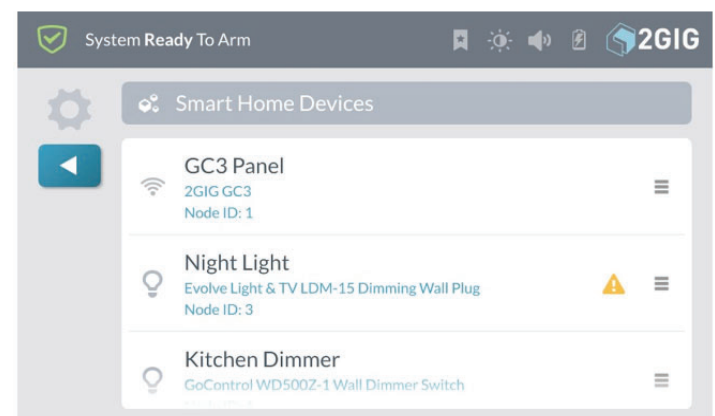

- To view the options available for a device, tap the menu button (☰).

Configure / Basic Control

The Configure option is device dependent, and only appears when a Z-Wave device has special configuration options.

This option lets you enter configuration parameters that are found in the device's User Guide.

1. Tap **Configure**.

Smart Home – Configure Option

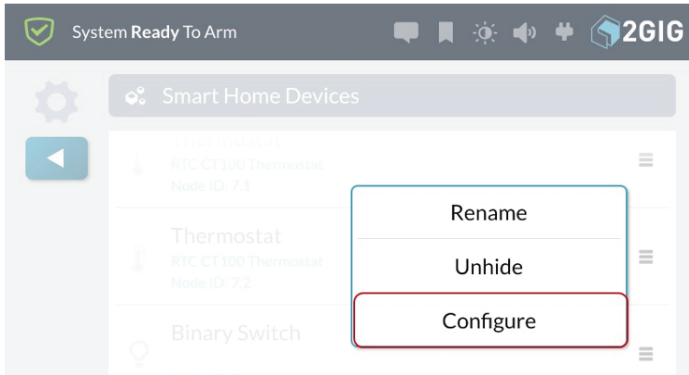

2. Tap **Set Value**.
3. At the **Set Value** screen, enter any number. See device User Guide.
4. Tap **Set**.

The Basic Set will be sent to the device.

Hide/Unhide

The Hide/Unhide option determines whether or not a device appears on Smart Home Control screens.

To hide a device on Smart Home Control screens:

1. Tap the menu button (≡) next to the device and tap **Hide**.

Smart Home Devices – Hide

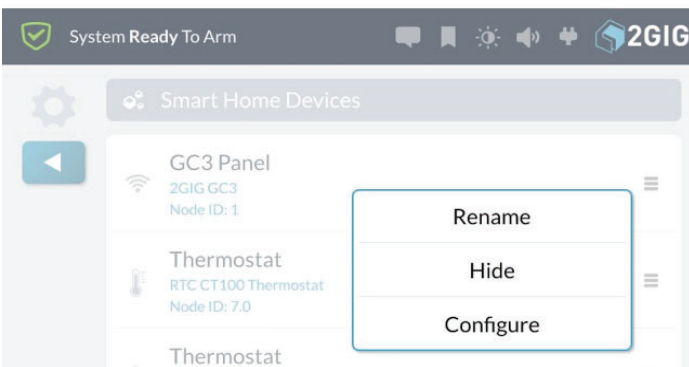

A confirmation screen appears.

Smart Home Devices – Hide Confirmation

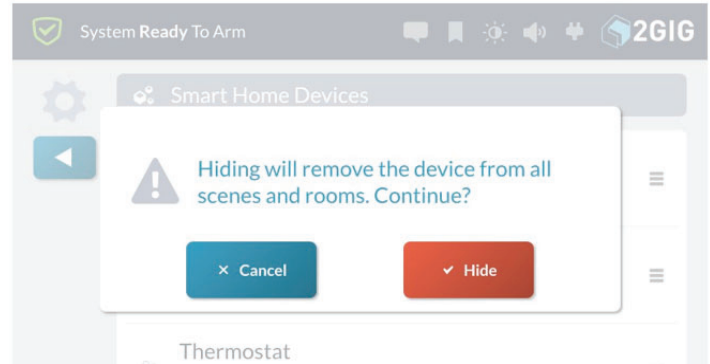

2. Tap **Hide** to prevent the device from appearing on Smart Home Control screens.

The device appears in gray text on **Smart Home Devices** screen.

Smart Home Devices – Hidden Device

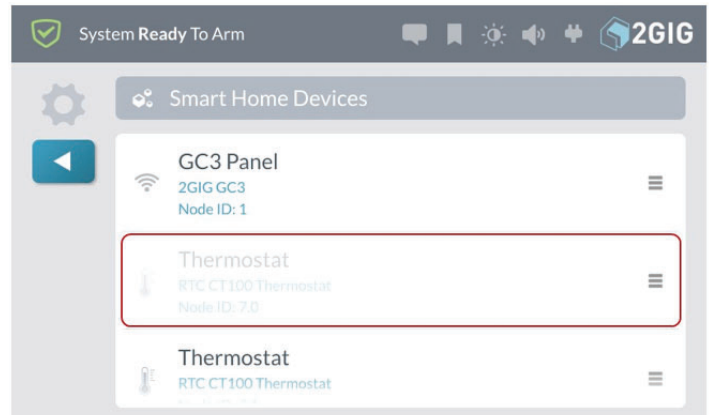

3. Tap  to return to the **Smart Home Settings** menu.

To make a hidden device visible

To make a hidden device visible on Smart Home Control screens:

1. Tap the menu button (≡) next to the device and tap **Unhide**.

Smart Home Devices – Unhide

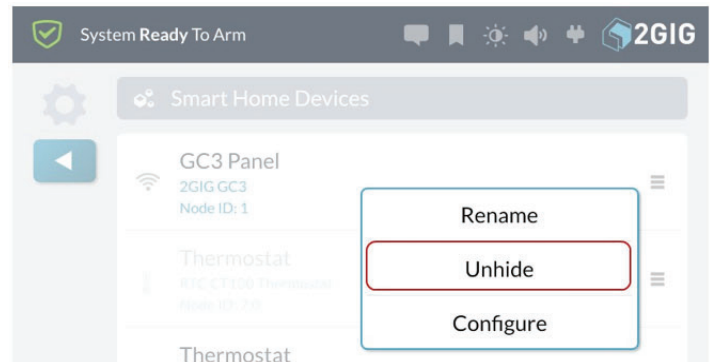

The menu closes, the device appears in normal text on the **Smart Home Devices** screen, and it also appears in Smart Home Control screens.

Smart Home Devices – Unhidden Device

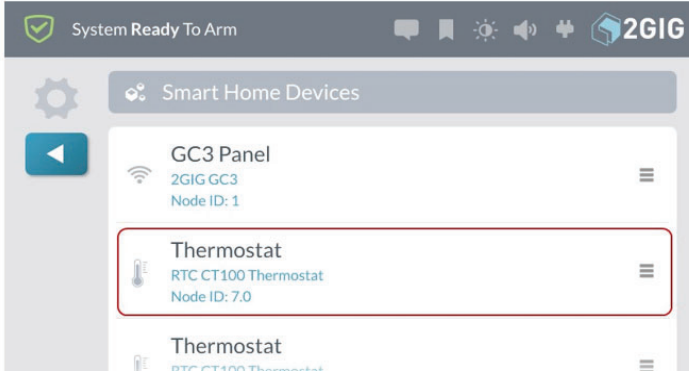

2. Tap  to return to the **Smart Home Settings** menu.

Identify

This option lets you identify a device from the control panel. Tapping **Identify** activates the device (for example, a light module will turn on and then turn off). This feature can be helpful if you add multiple devices to the system without renaming them at the time of installation.

Smart Home Devices – Identify

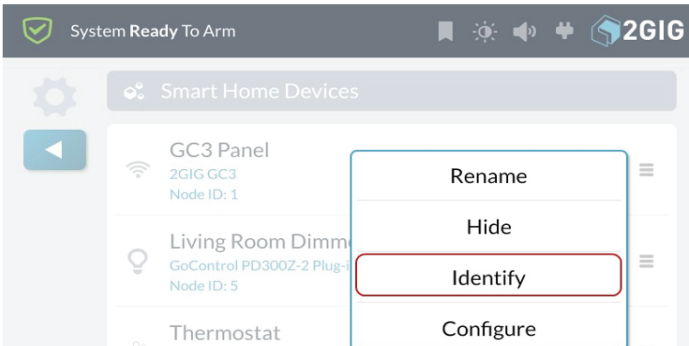

Remove

This option lets you remove a non-communicating node from the system. This option only appears for a device that is not communicating with the system.

Note: Non-communicating devices are indicated by an alert icon (⚠).

To remove a non-communicating node from the system:

1. Tap the menu button (≡) next to the non-communicating device and tap **Remove**.

Smart Home Devices – Remove

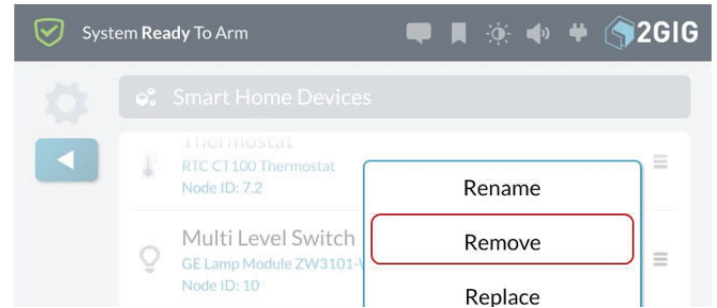

A confirmation screen appears.

Smart Home Devices – Remove Confirmation

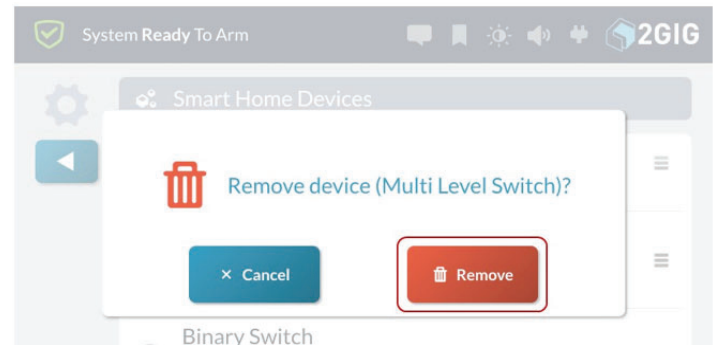

2. Tap **Remove** to delete the device from the network.
3. Tap  to return to the **Smart Home Settings** menu.

Rename

This option lets you rename devices that have already been added to the system.

To rename a device:

1. Tap the menu button (≡) next to the device and tap **Rename**.

Smart Home Devices – Rename

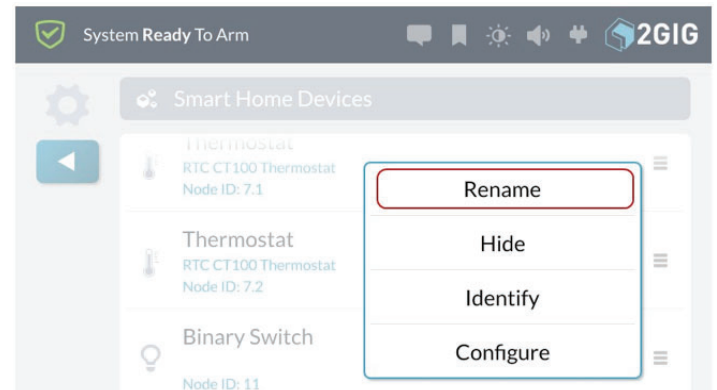

An onscreen keyboard appears.

Smart Home Devices – Enter a name for the device



2. Enter a new name for the device and tap **Done**.

The system reveals the new name on the Smart Home Devices screen.

Smart Home Devices – New Device Name

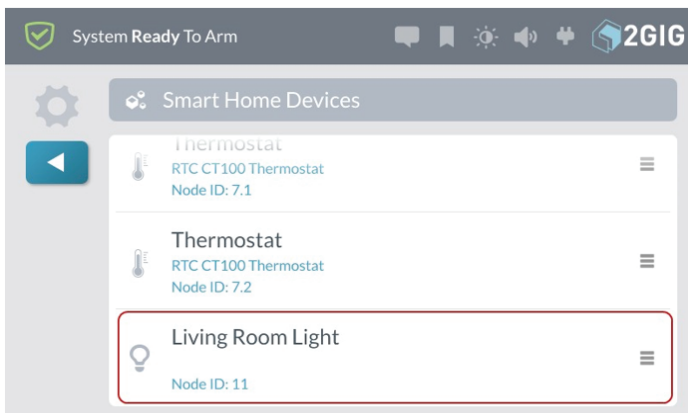

3. Tap  to return to the **Smart Home Settings** menu.

Replace

This feature lets you replace a non-communicating device with an identical device maintaining the same node number and other mesh network settings. This makes it easier to replace a device that is no longer working and is only available for a non-communicating device.

Note: Non-communicating devices are indicated by an alert icon (⚠️).

To replace a non-communicating device:

1. Tap the menu button (☰) next to the non-communicating device and tap **Replace**.

Smart Home Devices – Non-Communicating Device

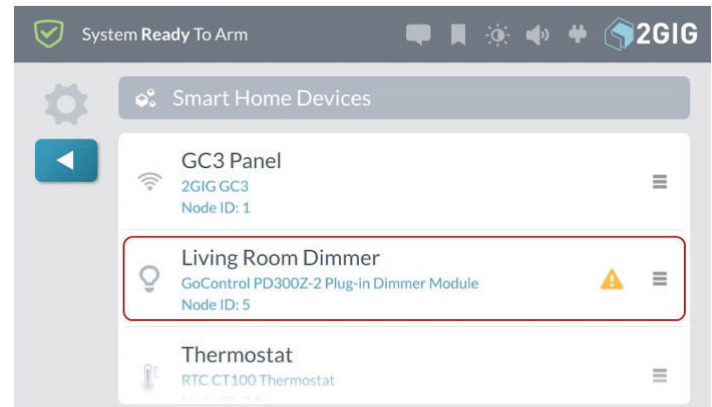

2. Tap **Replace**.

Smart Home Devices – Replace

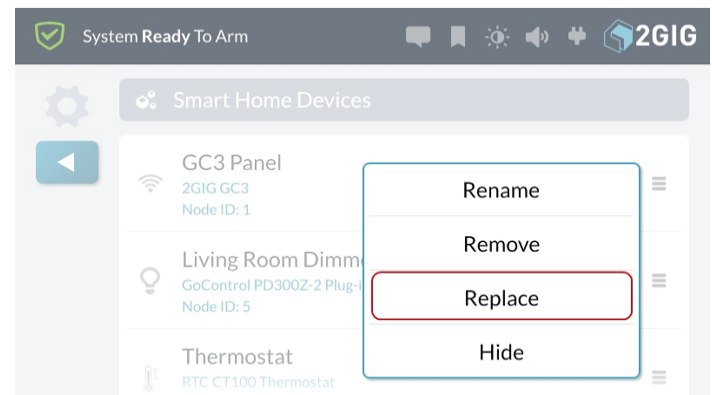

A **Listening for Replacement Device** screen appears.

Smart Home Devices – Listening For Replacement Device

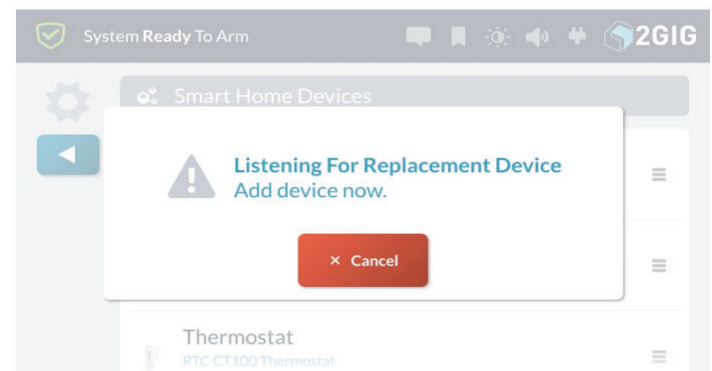

3. Walk to and trigger the replacement device on the network. For example, if you are replacing a Z-Wave light bulb, turn the light bulb ON.

A confirmation dialog appears when the replacement is finished.

Smart Home Devices – Replacement Finished



4. Tap **OK** to close the confirmation dialog.
5. Tap  to return to the **Smart Home Settings** menu.

Associating Z-Wave Devices

The Association function provides a means of enabling individual network devices to communicate directly with each other.

To associate Z-Wave devices:

1. At the **Home** screen, tap **System Settings**.

Home—System Settings

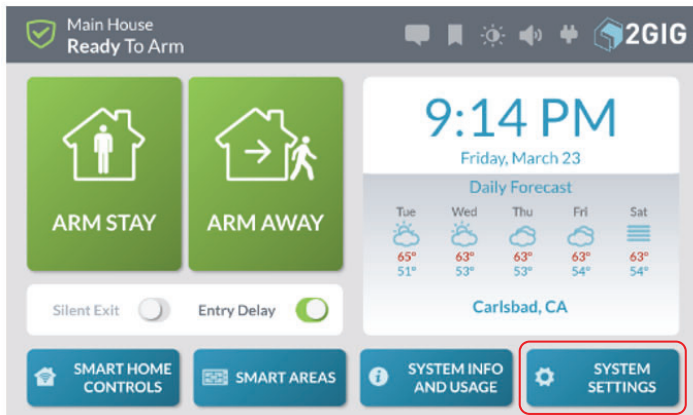

2. Enter the Master User Code to access the **System Settings** screen.

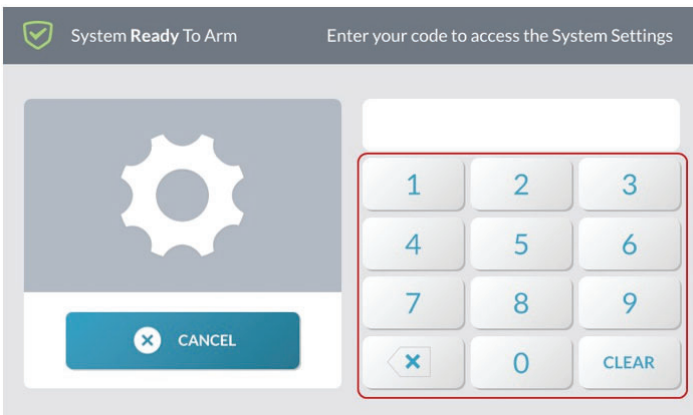

3. At the **System Settings** menu, tap **Smart Home Settings** on both Control Panels.

System Settings—Smart Home Settings

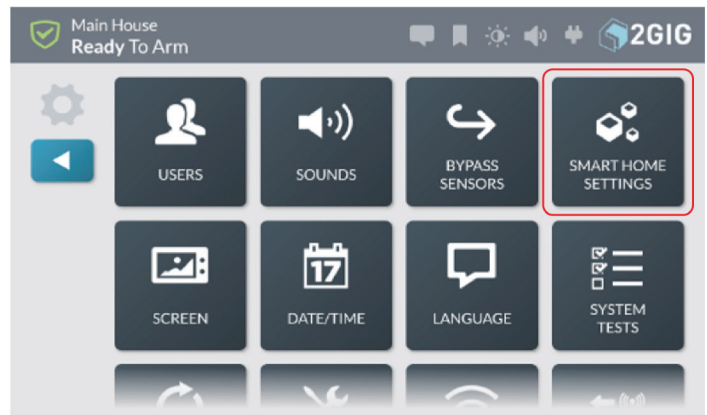

4. At the **Smart Home Settings** menu, tap **Device Association**.

Smart Home Settings—Advanced Settings

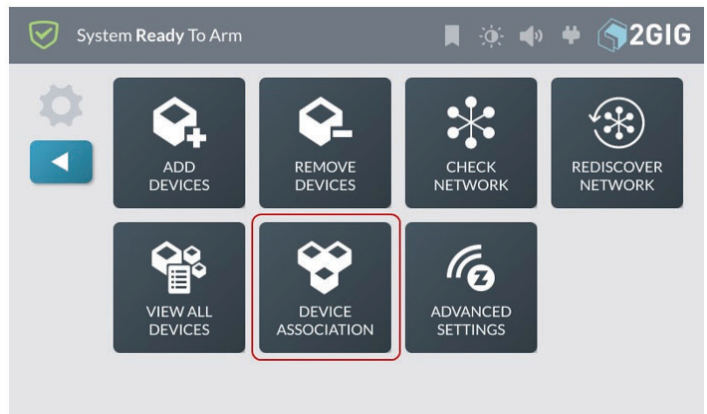

5. At the **Z-Wave Association** screen, tap the **Manage** button next to the device that will act as the controller.

Z-Wave Association—Manage

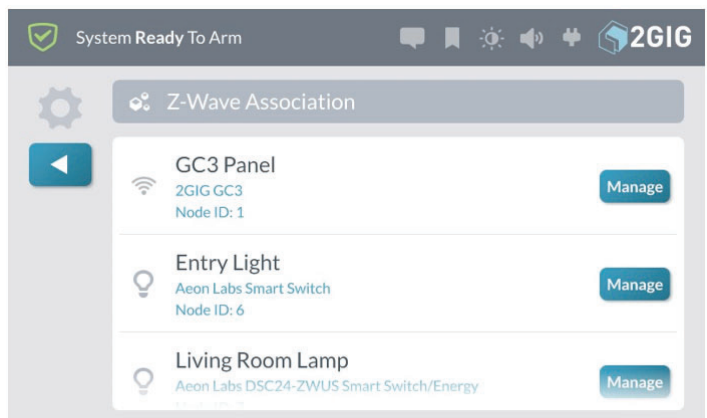

6. Tap **Edit Group** to select the Group for the association.

Z-Wave Association—Edit Group

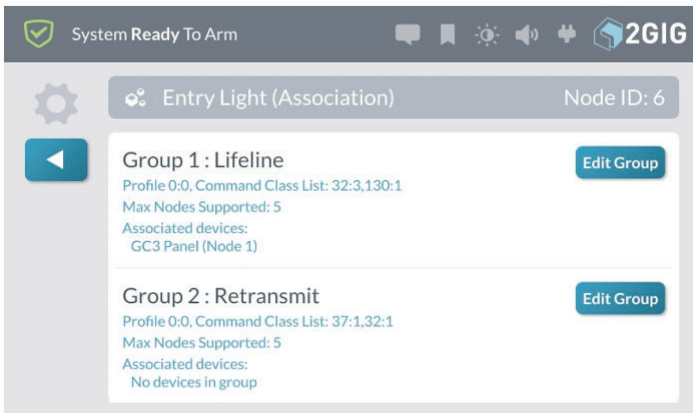

7. Select the devices to be associated with the controller device and tap .

Z-Wave Association Device

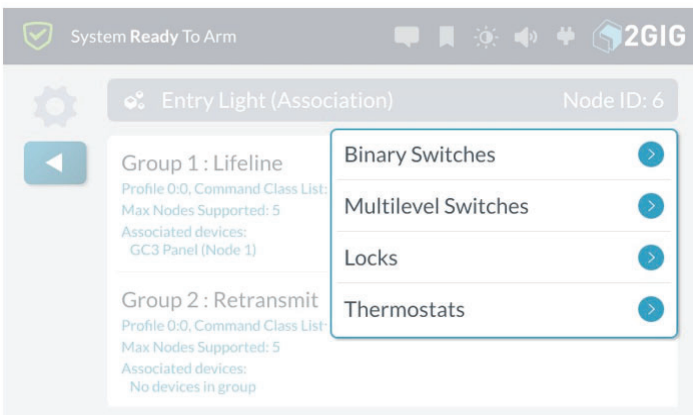

8. Tap  to return to the **Smart Home Settings** menu.

Note: Refer to device documentation for information about the association groups supported by the device.

Reset the Controller

You can reset the Z-Wave controller to remove all Z-Wave devices from the network and to reset the controller to its factory default state.

Note: Use this procedure only in the event that the network primary controller is missing or otherwise inoperable.

To reset the controller:

1. Navigate to the **Smart Home Settings** menu. See “Navigate to the Smart Home Settings Menu.”
2. At the **Smart Home Settings** menu, tap **Advanced Settings**.

Smart Home Settings—Advanced Settings

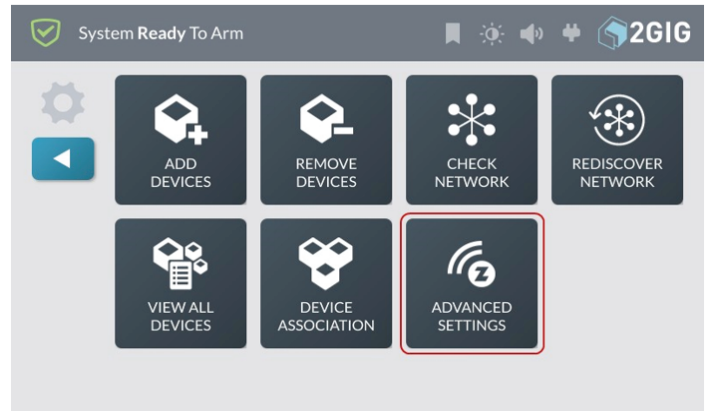

3. At the **Advanced Settings** menu, tap **Reset Controller**.

Advanced Settings—Reset Controller

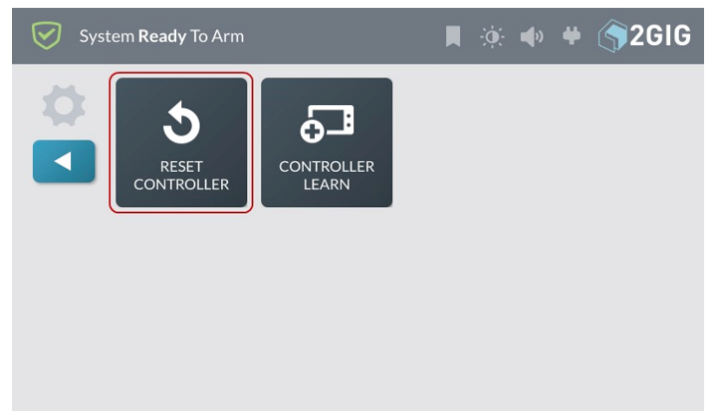

4. At the **Reset the Z-Wave Controller** screen, tap **Reset Controller**.

Reset the Z-Wave Controller—Reset Controller

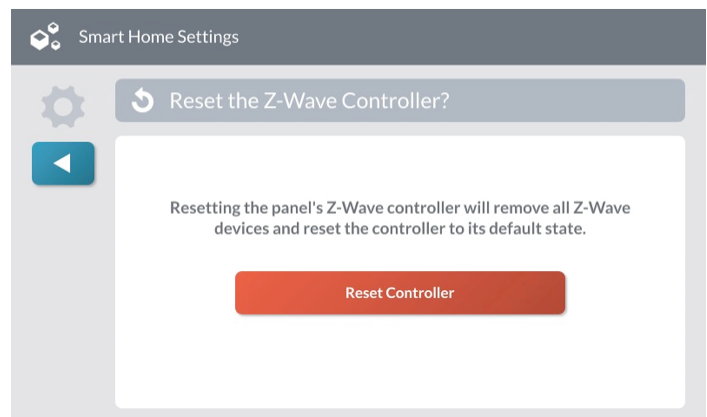

Note: Resetting the controller will delete all node information from the GC3 Control Panel. Any

devices that were part of the mesh network will need to be manually removed from the network before they can be added to a network.

While the controller is being reset, the Working message appears. Tap **OK** or wait a few seconds for the message to close automatically.

Reset the Z-Wave Controller—Working

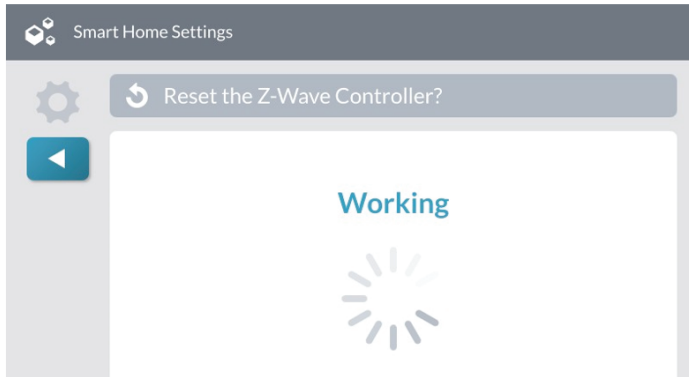

5. When the controller is reset, the following message appears. Tap **OK** or wait a few seconds for the message to close automatically.

Z-Wave Controller Reset Message

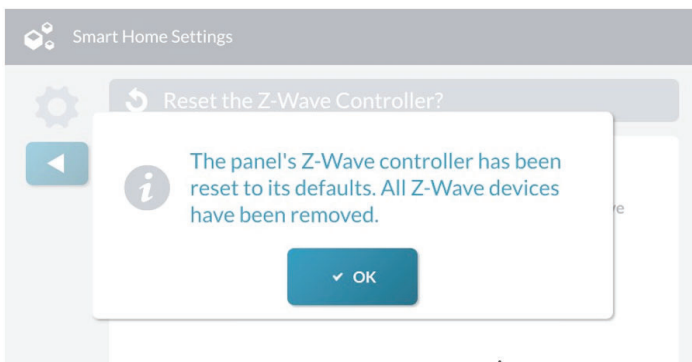

Learn Controller

The GC3 Panel can be added to an existing Z-Wave network as a “secondary” controller (this process is also called “copy” or “replication”).

When the GC3 Panel acts as a secondary controller, devices can only be added to or removed from the Z-Wave network at the primary controller. Other than that, all functions are available to either controller.

To add the GC3 Panel as a secondary controller for an existing Z-Wave network:

1. At the existing controller, add the GC3 Panel to the Z-Wave network. (If the existing controller is a GC3 Panel, see “Add a New Device.” Otherwise, refer to the documentation that came with the Z-Wave controller.)

2. At the **Home** screen on the secondary GC3 Panel, tap **System Settings**.

Home—System Settings



3. Enter the Master User Code to access the **System Settings** screen.

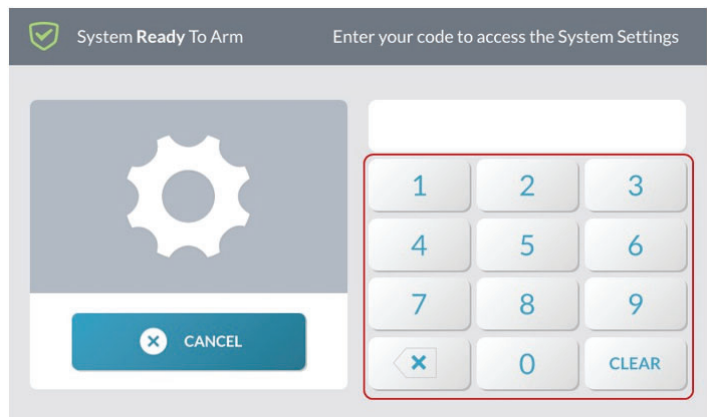

4. At the **System Settings** menu, tap **Smart Home Settings**.

System Settings—Smart Home Settings

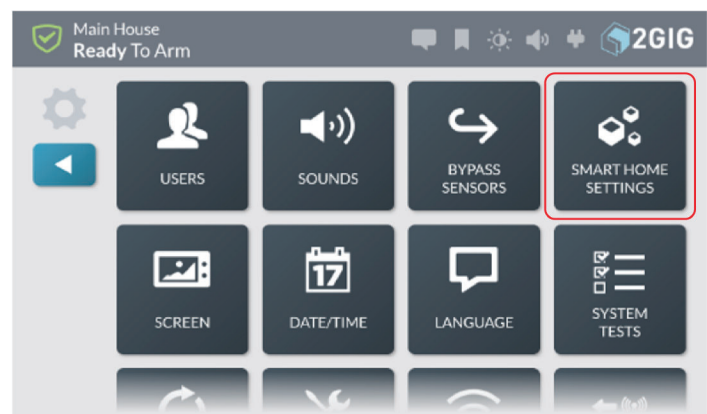

- At the **Smart Home Settings** menu, tap **Advanced Settings**.

Smart Home Settings—Advanced Settings

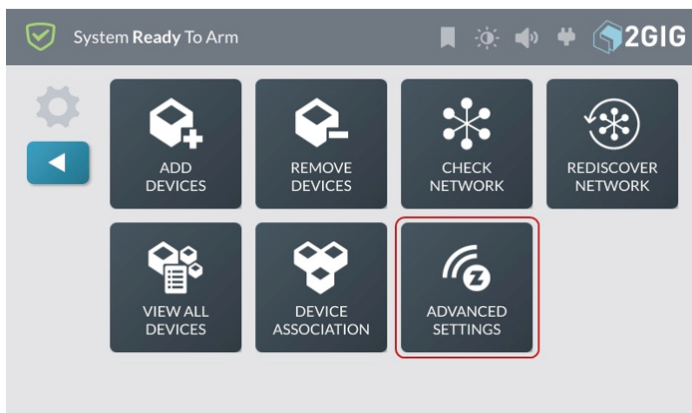

- At the **Advanced Settings** menu, tap **Controller Learn**.

Advanced Settings—Controller Learn

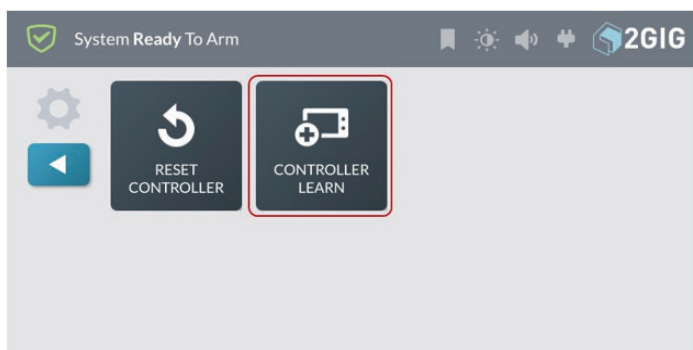

The GC3 Panel displays a “Learning Z-Wave Controller” message and waits for a signal from the primary controller. The synchronization takes time, depending upon the number of Z- Wave devices in the network.

Note: If a new Z-Wave device is added to the network, the secondary controller must be re-learned into the network.

Testing the Installation

Disable the Piezo Sounder

To disable the system’s sounder, navigate to the **Installer Toolbox**. Then tap **Disable Sounder**. At the **Sounder Disabled** message, tap **OK**. The sounder is disabled for 30 minutes (or until you tap the **Re- enable Sounder** button).

Perform a Walk Test

After installing the system, sensors, and peripherals, perform a walk test to ensure proper console operations and to test wireless reception and signal strength. To open the **Walk Test** menu, navigate to the **Installer Toolbox**. Then tap **Walk Test**.

- » To test wireless reception and signal strength, tap **Sensors Test**. Then walk to and trigger each sensor.

Walk Test—Sensors Test Screen

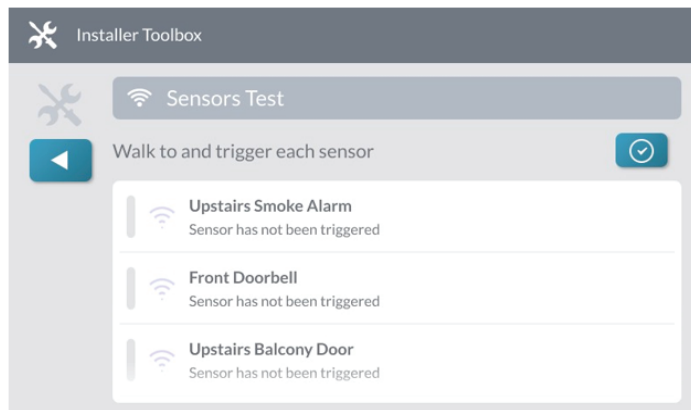

- » After you have tested all sensors, press .
- » To test the console operations, tap **Console Test**. Then tap each button and respond **Yes** or **No** to each question.

Walk Test—Console Test Screen

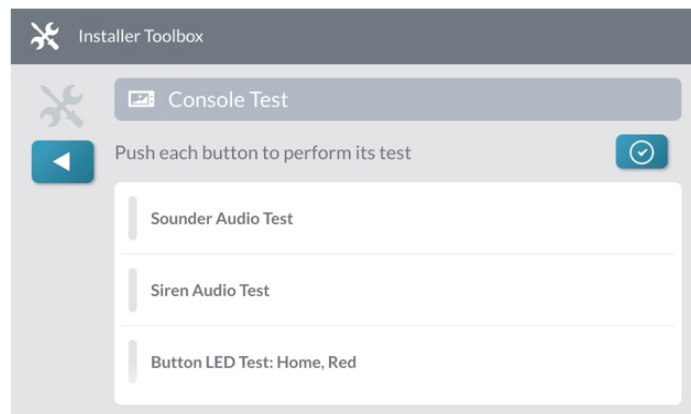

- » After you have tested all console functions, press .

Note: For compliance with *ANSI/SIA CP-01-2010*, when you tap **Sensors Test** or **Console Test**, the system sends a *Walk Test Started* message to the Central Station. When you exit the test, the system sends a *Walk Test Terminated* message to the Central Station.

Verify the Radio Status

After installing the Cellular Radio Module for the first time, perform a radio test to check the cell signal strength, confirm the serial number of the module, and view other information about the cellular radio connection. This is a helpful tool to use when troubleshooting the installation. To open the Radio Test menu, navigate to the **Installer Toolbox**. Then tap **Radio Test**. At the **Radio Status** screen, tap **Start Radio Test**.

When the test is complete:

- » A “Success” message indicates the module is functioning properly (see next image).
- » A “Cell Radio Module Status Not Detected” message indicates a module is not properly installed. See “Install/Replace the Cellular Radio Module.”
- » A “Remote Services Provider is Not Set” message indicates that the installer has not programmed a Remote Services Provider for the GC3 Panel. See “Q7: Remote services provider.”

Installer Toolbox—Radio Status Test Success

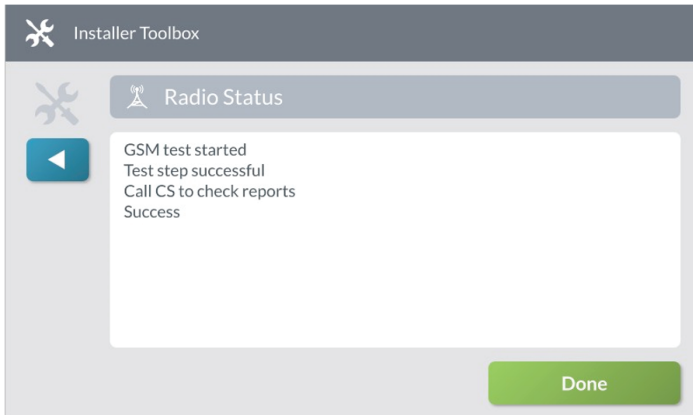

Adding a Demo Video

Demo Mode

The **Demo Mode** allows a dealer to add a *Demo Video* to the panel.

To add a Demo Video:

1. Navigate to the **Installer Toolbox** and tap **Demo Mode**.

Installer Toolbox - Demo Mode

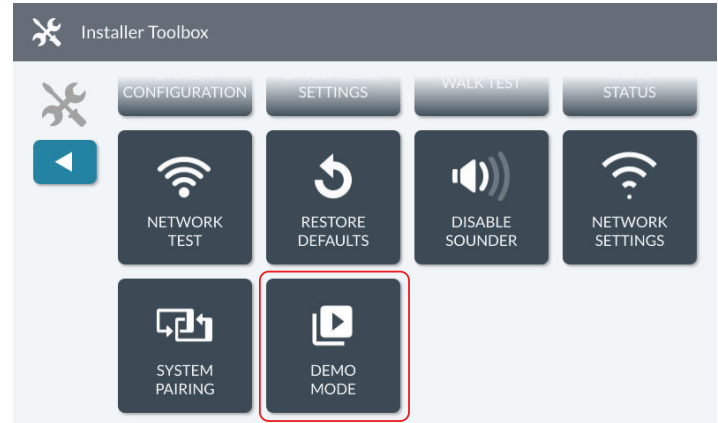

2. Copy an mp4 video onto a USB drive.

Notes:

- » **File size** - cannot exceed 200mb
 - » **Recommended Resolution** - 720p/30 frames per second, not to exceed 20Mbps
3. Insert the USB drive into the top of the panel.
 4. Press the **Replace Video** button.

Demo Mode - Replace Video

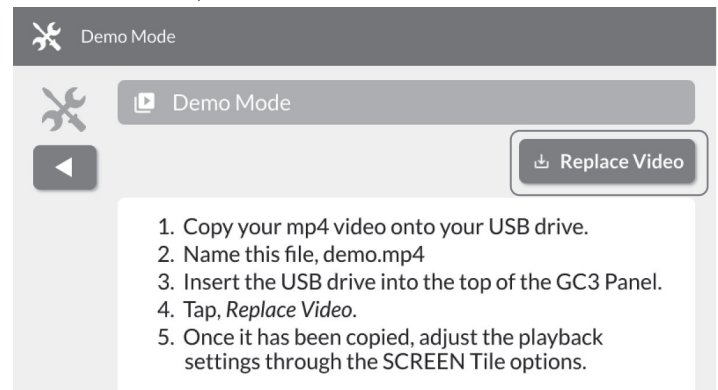

5. The mp4 file will copy to the panel.

Demo Mode - Copying to Panel

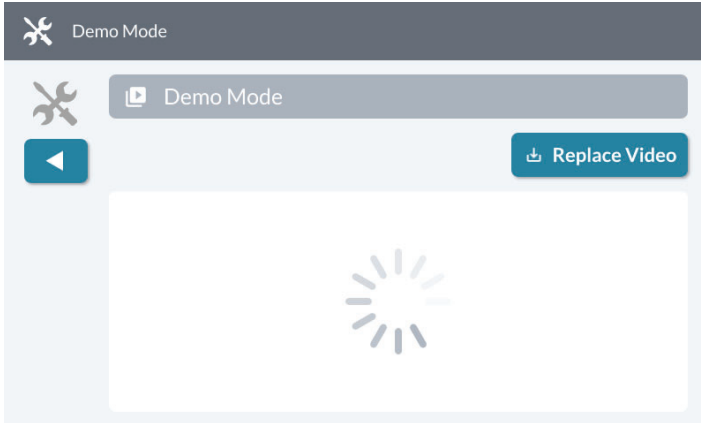

6. When successful, the panel will display message.

7. Press **OK**.

Demo Mode - Press OK

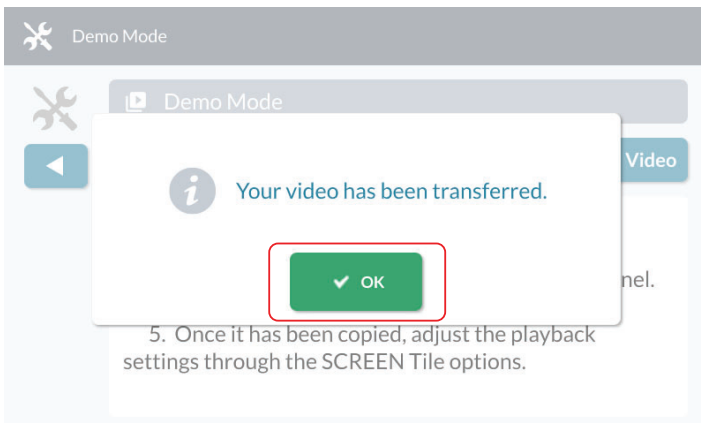

8. Once the file is transferred, tap  to exit the **Installer Toolbox**.

9. Navigate to the **Home Screen** and tap the **System Settings**.

10. Select the **Screen** tile.

System Settings - Screen Tile

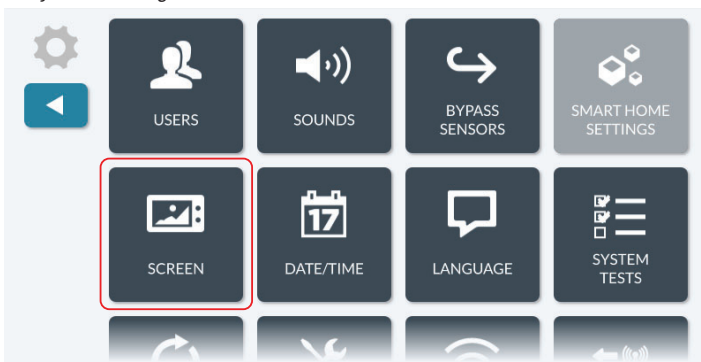

11. In the **Screen Saver** section, select **DEMO MODE**.

Screen - Demo Mode

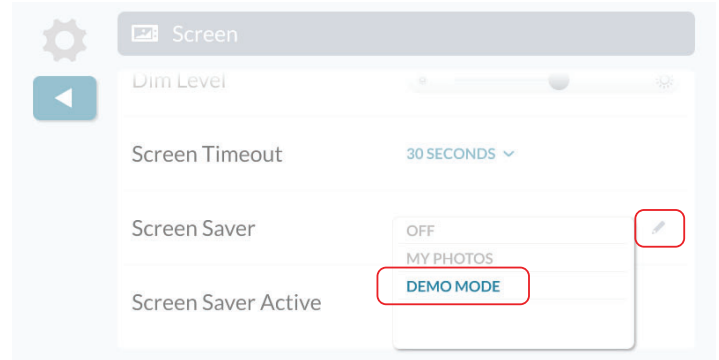

12. Press the edit icon in the Screen Saver section.

13. Set the volume for the video playback.

Demo Mode - Video Volume

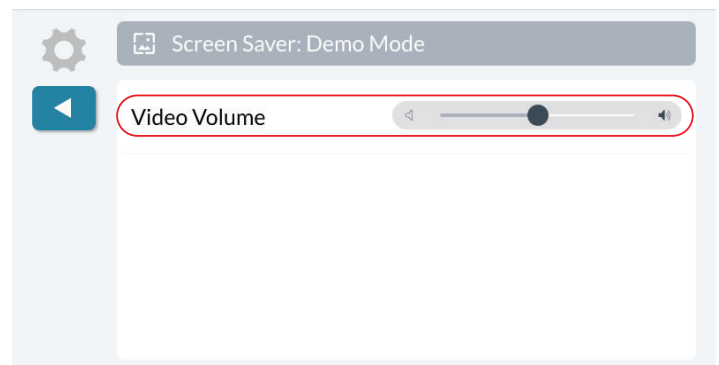

14. Tap  to exit.

Notes:

- » The *demo video* will play when the screen times out and will then return to the home screen. It will then repeat each time the screen times out.
- » To turn off the *demo video*, change the **Screen Saver** setting to “OFF” or “MY PHOTOS.”
- » See “User Guide” for additional screen settings.

Screen - Screensaver Modes

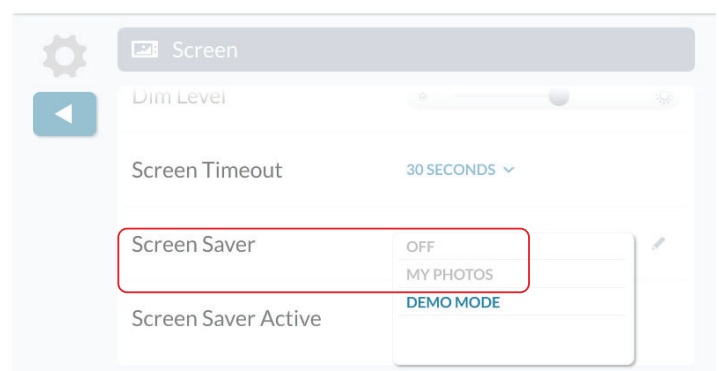

[THIS PAGE LEFT INTENTIONALLY BLANK]

Limited Warranty

This product is warranted against defects in material and workmanship for three (3) year. This warranty extends only to wholesale customers who buy directly from Nortek Security & Control LLC or through Nortek Security & Control's normal distribution channels. Nortek Security & Control LLC does not warrant this product to consumers. Consumers should inquire from their selling dealer as to the nature of the dealer's warranty, if any.

There are no obligations or liabilities on the part of Nortek Security & Control LLC for consequential damages arising out of or in connection with use or performance of this product or other indirect damages with respect to loss of property, revenue, or profit, or cost of removal, installation, or re-installation. All implied warranties for functionality are valid only until the warranty expires. This Nortek Security & Control LLC Warranty is in lieu of all other warranties, expressed or implied.

All products returned for warranty service require a Return Authorization Number (RA#). Contact Returns at 1-855-546-3351 for an RA# and other important details.

Waste Electrical and Electronic Equipment (WEEE) Statement

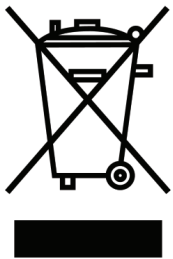

This symbol on a product or on its packaging indicates that this product is not to be thrown away with everyday waste.

Instead, it is your responsibility to dispose of electrical and electronics equipment by handing it over to a designated collection point for the recycling of waste electrical and electronic equipment (W.E.E.E.). The separate collection and recycling of your waste electrical and electronic equipment at the time of disposal will help to conserve natural resources and ensure that it is recycled in a manner that protects human health and the environment. For more information about where you can drop off your waste equipment for recycling, please contact your local city office, or your household waste disposal service, or the shop where you purchased the product.

WARNINGS

Limitations of Alarm Products

This product should be tested periodically to make sure it is working properly. The product, if used properly, may reduce the risk of burglary, robbery, and other adverse events that have the potential to result in injury or loss of life; however, Nortek Security & Control is not an insurer. This product is neither insurance nor a guarantee that such an event will be prevented, and users should protect themselves with proper insurance. Nortek Security & Control makes no representation that this product cannot be compromised or circumvented, that it will provide an adequate warning, or that it will prevent any personal injuries, property damage, or other losses. Like any alarm product, it may be bypassed, it is subject to compromise, and it may fail to warn for a variety of reasons, including, but not limited to: improper installation or positioning; improper maintenance; tampering; dead or improperly installed batteries; sensing limitations; component failures; receivers; intrusions may be outside of a product's designated range and certain environmental conditions may impact performance, and audible alarm signals may be outside of hearing range, muted by doors, walls, and floors, unheard by deep sleepers or the hearing-impaired, or overwhelmed by other sounds.

Risk of Noise Induced Hearing Loss

The Alarm is equipped with a warning siren. Exposure to high sound levels or prolonged exposure to the warning siren can result in Noise Induced Hearing Loss (NIHL)

ALARM DEALER INFORMATION

Company Name:

Your Account Number:

Installation Date:

10023748A X3